

REDTIGER

F7N

User Manual



Contact us:



LINE



WhatsApp

E-mail: redtiger.cam@gmail.com

Welcome to use Ultra HD mini dash camera F7N
•Please read this manual carefully before use.If you have any questions please feel free to contact us.

DIRECTORY

Attention	03
Package Contents	04
Appearance	05
Button Function	07
About the Micro SD Card	08
Installation	09
Power ON/OFF	12
Recording Mode	14
Photo Mode	16
Playback Mode	17
Play on Computer	19
About WIFI & APP	20
About the Setting menu	24
Parking Monitoring Mode (Optional)	26
FAQ	27
Safety Instructions	29
Product Specifications	30

Attention

1. The driver should not operate this product while driving. Aside or carelessness in front of you may cause traffic problems. When operating by the driver, be sure to park the vehicle in a safe place before proceeding.
2. This product is intended to be used as a reference material in the event of an accident. We do not guarantee its effectiveness as complete evidence.
3. Please note that this product may infringe on privacy and other rights depending on how it is used. We are not responsible for these cases.
4. Since this product uses a wide-angle lens, part of the image may be distorted. It also differs from the actual perspective. This is a characteristic of wide-angle lenses and is not a malfunction.
5. Please use the original power cable provided in package, do not use other power cables. Other power cable may make the camera mirror unstable even damaged.
6. Do not use Socket distributor.
7. Although we offer brackets for rear camera to install inside car, we don't suggest to install in car. Because the windshield glass and film will decrease the color saturation and sharpness of the video.
8. This product is for DC12V / 24V vehicles only.
9. The specifications and appearance of this product are subject to change without notice for improvement.

Package Contents



Dash cam



Rear camera

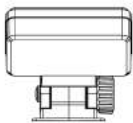

built-in GPS

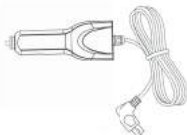

Car cigar



Rear camera cable



Electrostatic adsorption



User manual

Appearance

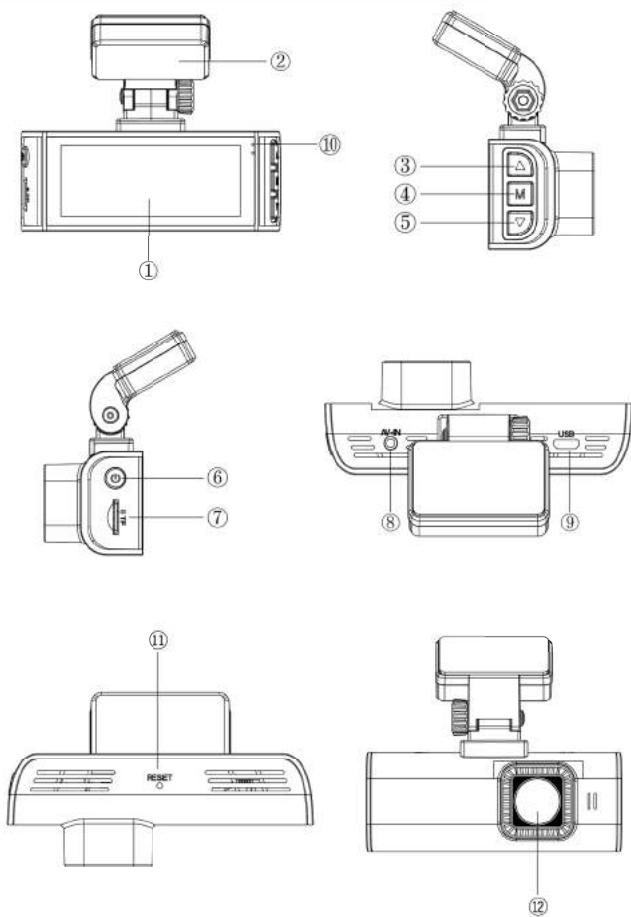

Appearance

- ① IPS display
- ② GPS built-in bracket
- ③ **【Up (▲)】**:
Short press: Video Lock (during recording)
Long press: WIFI on / off
- ④ **【Menu/Mode (M)】**:
Short press: Various mode setting menus will appear
Long press: Switch between photo / playback / recording mode
- ⑤ **【Down (▼)】**:
Short press: Recording on / off
Long press: Sound Recording on / off
- ⑥ **【Power (⏻)】**:
Press and hold the power button for 3 seconds to turn off the power
In various modes, you can check the displayed items by short press
- ⑦ Micro SD card slot
- ⑧ Rear camera input terminal (AV-IN)
※ When installing the rear camera, make sure that the image is not upside down on the LCD screen before installing it.
- ⑨ Power cord connection port
- ⑩ Operating status indicator lamp:
A lamp informs the operating status
※ Flashes red while recording.
- ⑪ Reset button (* Reset the and restart the system.)
- ⑫ Lens: Please remove the lens protection film before use

Button Function

Button	Operating	Recording mode screen	Setting menu	Photo mode	Playback mode	
【Up(▲)】	Short press	Video lock (During recording)	Up(Forward)	Zoom in	On playback	Playback stopped
	Long press	WiFi on / off	-		Fast rewind	Up(Forward)
【Mode (M)】	Short press	Enter the settings menu (Stop recording)	YES	Switch to Playback mode	Stop	Enter the playback menu
	Long press	Switch to photo mode	-		Switch to recording mode	
【Down(▼)】	Short press	Recording on / off	Down (Next)	Zoom out	Fast forward	Down (Next)
	Long press	Sound recording on / off	-		-	
【Power (⏻)】	Short press	Screen off/display view switch	Return	Take photo	Pause	Play
	Long press	POWER OFF				

※ Long press: Press and hold the button for 3 seconds.

Mode Switch

When you turn on the power, the dash cam will start recording automatically. Press [Down] button to stop recording, then switch the mode.

Recording Mode $\xrightarrow{\text{Short press M button}}$ Setting menu

Recording Mode $\xrightarrow{\text{Long press M button}}$ Photo Mode

Long press M button

Short / Long press M button

Playback Mode

※ Please note that M button is disabled during recording. Press the ▼ button to stop recording and then press M to move to the menu screen.

About the Micro SD Card

When using a new MicroSD card, be sure to format it on the main body.

1. Do not remove or insert a Micro SD card while the power is on.
2. Use a Micro SD card with Class 10 or higher(8GB~258GB).
3. A micro SD card that has reached the end of its life will not operate normally due to a card error such as being unable to be read by a computer.
4. For stable use, it is recommended to format the microSD card regularly.Recommend: Once a month.

Note:Formatting will erase all recorded data.

How to insert and remove Micro SD card

1. Pay attention to the orientation of the MicroSD card and insert it into the slot.

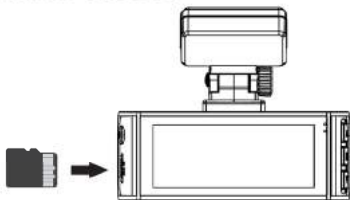

2. Make sure that the microSD card is securely inserted inside the slot.

※Insert until you hear a click.

3. When removing the microSD card, push in the microSD card and pull it out after the microSD card pops out a little.

Installation

How to install the main body

1. Remove dirt and grease from the windshield and attach the electrostatic adsorption sheet to the windshield.

How to use the electrostatic adsorption sheet

Since the adhesive strength is strong on both sides and it is difficult to peel off once it is pasted, it will be troublesome if the pasting position is incorrect. Therefore, the electrostatic adsorption sheet is attached to the windshield. You can easily readjust by sticking the double-sided tape on the mount and peeling it off.



2. Peel off the double-sided tape attached to the GPS built-in bracket and attach it on the electrostatic adsorption sheet on the windshield.

※ To strengthen the fixing force, do not attach the main body and leave it for 24 hours or more.

※ Re-sticking may weaken the adhesive strength of the tape and cause it to fall off.

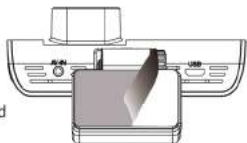

3. Insert the attached cigar plug cord into the jack of the main body and the cigar lighter socket of the vehicle.

※ Connect the cigar plug cord connector in the correct orientation.

※ Connecting in the wrong direction may cause malfunction or damage. If you cannot connect successfully, check the connection part carefully before connecting.



Installation

How to install the rear camera

Step 1: Fix camera with 3M adhesive
Find a best location, tear off the 3M adhesive on the rear camera, fix the rear camera near by the car license plate lamp. (if you need to adjust the angle, please attach the rear camera bracket to the rear camera and tighten it with screws first).



Step 2: Remove the Panel
Remove your trunk's interior panel to expose the cars rear wiring chambers. Pop open your trunk and look for a solid interior panel covering the opposite side of your license plate mounting area. Then, insert a trim removal tool or other thin device behind the panel and pry it off.



Step 3: Snake the cable
Use a trim removal tool to pop out tailgate trim, then run the cable from outside of the car into the trunk of your car.



Step 4: Connect the rear cameras power cable to the extension cable.
After snaking your rear camera's extension cable, connect the power cable to your rear camera's extension cord.

※The red wire on the rear camera cable does not need to be connected. (Designed for another model of our products)



Installation

Step 5: Route your rear camera's power cable to the front of the car.

If you'd like, use a trim removal tool to pop out the headlining panel directly above your windshield. Then, run your cable through the exposed chamber.



Step 6: Power on the dash cam with box included car charger, don't charge it with your own chargers.



Note

- For safe driving, install and wire so that it does not obstruct the driver's view or drive. It is recommended to install within 20% of the entire windshield from the top of the windshield.
- Please use the original power cable provided in package, do not use other power cables. Other power cable may make the camera mirror unstable even damaged.
- Do not use Socket distributor.
- Please tear off the films on the screen and lens before using.
- Connect all accessories before turning on the power.
- Do not connect or disconnect the rear camera cable while the power is on. It will be the cause of the failure.
- When installing the rear camera, make sure that the image is not upside down on the LCD screen of this product before installing it.

Power ON/OFF

<Power ON>

- If you turn on the engine (ACC on) while the cigar power adapter is connected, the power will be turned on automatically and the opening screen will be displayed.
- Press and hold the power button to turn off the power during startup, and then briefly press the power button again to turn on the power of the unit and display the opening screen.



MicroSD card check function

This product will check the MicroSD card at startup and will announce if it is not inserted or damaged, that can prevent missed shots.

<Power OFF>

- When the engine is turned off, the power is automatically turned off.
- If you press and hold the power button while the power is on, the power of this unit will be turned off.

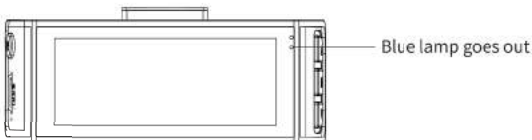

Power ON/OFF

About the reset button

If the dash cam stops working or malfunctions, push the reset hole on the main body with a fine-tipped object to restart.

Even if it is reset, the settings and recorded data will not be deleted.

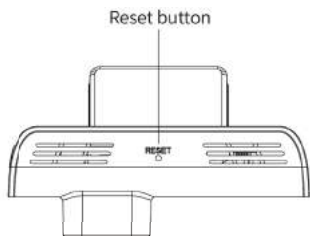

Recording Mode

Recording screen



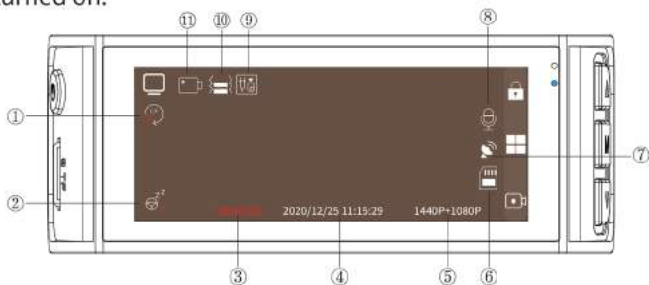



● When the engine is turned on, the power is automatically turned on.



- ① Loop recording: Generates in 1 min/ 3 mins/ 5 mins per file
- ② Fatigue Driving: Displayed when this function is turned on
- ③ Recording: Displays the recording status and recording time. The red icon flashes during recording to show the current video recording time
- ④ Date: Display the date and time of the machine
- ⑤ Display recording resolution
- ⑥ Show SD card status
- ⑦ GPS: Display GPS status
- ⑧ Display voice recording status
- ⑨ Indicates that the rear camera is connected
- ⑩ G-Sensor sensitivity display
- ⑪ Show video recording mode

Recording Mode

Button function in recording mode

Button	icon	Function
		Long Press to power on/off You can switch the view display by short press. <small>(Front and rear camera → Front camera → Rear camera → Front and rear camera → Screen off)</small>
		Long Press to turn on/off the WIFI function <small>(If turned on, the password will be displayed. You can use the power button to check)</small> You can manually lock the file by short press
M		Long press to switch mode Short press to enter the setting menu
		Long press to turn on/off sound recording Short press to start/stop recording

Note:

There are four recording resolutions: front 2160P, front 1440P, front 2160+ rear 1080P, front 1440P + rear 1080P. When installing the rear camera, the default resolution is front 1440 + rear 1080P. If you set the front 2160P and front 1440P, you can display and switch the screen of the rear camera, but only the data of the front camera is recorded.

Photo Mode

Press and hold the M button in video recording mode to switch to photo mode. (If recording is in progress, you need to stop recording)

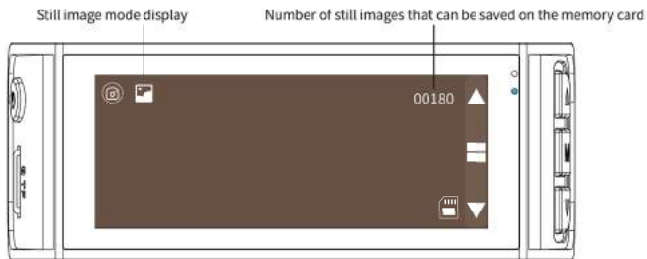

Button function in photo mode

Button	icon	Function
		Long press to power off Short press to take a photo
		Long / short press: Zoom in
M		Long / short press: Switch to playback mode
		Long / short press: Zoom out

Playback Mode

File selecting screen

After the engine is turned on, the power will automatically turn on.

In video recording mode, long press [M] to switch to photo mode. (If recording is in progress, you need to stop recording)
Short press in photo mode to switch to playback mode.

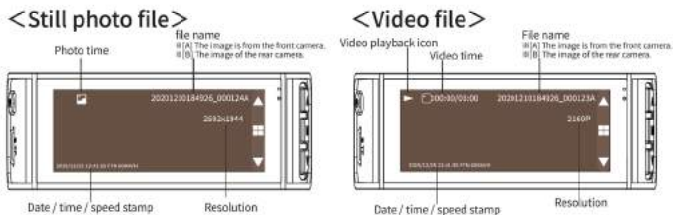

Playback menu



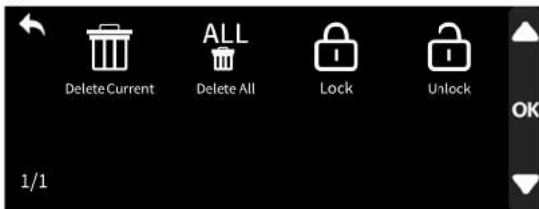



In the playback mode, short press the M button to enter the playback menu.









- [Delete Current]: Delete the displayed file
- [Delete All]: Delete all files
- ※ Unable to delete locked file. You can manually unlock and then erase.
- [Lock]: Manually lock the display file
- [Unlock]: Manually unlock the displayed files

Playback Mode

Button function in playback mode(playback stopped / file selection screen)

Button	icon	Function
		Short press to start/pause the displayed file
		UP(forward): Return to the previous file
M		Short press to enter the setting menu Long press to switch to recording mode
		Next: Move to the next file

Button function in playback mode(On playback)

Button	icon	Function
		Short press to start/pause the displayed file
		Short press: Fast rewind (slow), double speed ⌘ Rewind: Play back to the beginning
M		Short press to stop playback (Return to the beginning of the display file)
		Short press: Fast forward / double speed Long press to switch to recording mode

Play on Computer

How to output data on computer:

① Data can be output by connecting the main unit to a personal computer using a USB cable.

※Some USB cables only have a charging function, not a data transmission function. Please use a USB cable with a data transmission function.

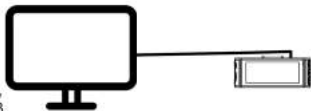

② Data can be output on computer by using a card reader.



The video recorded by this product can be displayed in conjunction with Google Maps by installing the dedicated viewer software on your computer.

※An internet connection is required.

Download URL: <http://www.gpsplayer.net/setup.html>

<About recorded files>

If you collide during recording, drive on bumpy roads or close the door tightly, the video will be locked automatically and the locked video will be automatically saved in the RO folder of TF card and will not be overwritten (When the recording is locked, a red lock icon in the center of the screen will be displayed). Press the "Up" button to manually lock the recorded video.

"XXXXXX_XXXXXXA": Front camera video

"XXXXXX_XXXXXXB": Rear camera video

About WIFI & APP

The app "Ucam" is a free app that allows you to operate this WLAN built-in drive recorder from your smartphone

About WIFI connection

① Download the "Ucam" app

Select [APP] from the main menu and press the [M] switch to display the QR code on the screen. Scan the QR code on your smartphone and download the "Ucam" app.



② WIFI function on

Select [APP] in the menu, and turn on the WIFI function, or press and hold the [▲] button in recording mode to activate the WIFI function.

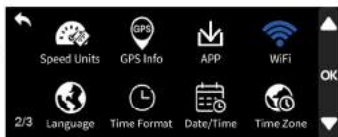

※ The WIFI name (F7N-XXXXXX) and password (initial password: 12345678) will be displayed on the screen after startup. You can check it with the power button.



About WIFI & APP

③ Connect your smartphone to WiFi
Select the WIFI name in the WLAN list on your smartphone and enter the password.

④ Launch the app "Ucam"
When the connection is completed, the running video screen will be displayed automatically on the phone.

Note:

- When connected to WIFI, the dash cam can only operate by phone.
- Press and hold the **[▲]** button to turn off WiFi.



Recording screen of the APP (e.g.IOS)



- ① Return to the front
- ② Video stamp
- ③ Switch the display view
- ④ Record button
(recording on / off)
- ⑤ Full screen display
- ⑥ Enter the setting menu
- ⑦ Data file
- ⑧ Take a photo

About WIFI & APP

Check / play data with APP



You can check and play the data by pressing  on the recording screen to enter the data file.

On the data file screen, press [Edit], select the file you want to download, and press [Download] to download the file and save it to the [local album] which you can find on the interface of APP, then you can download to the smartphone album.

Note: You cannot delete the lock file unless unlocked the file manually.

You can select a local album, play the downloaded data, and view it in conjunction with Google Maps. (Internet connection environment is required.)



About WIFI & APP

Edit and share with the APP

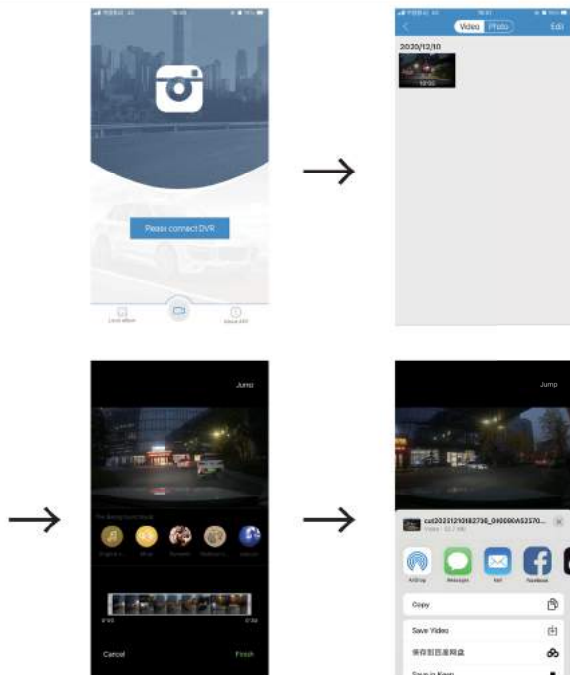

You can enter local albums, edit downloaded files and share them in the APP interface.

About the Setting Menu

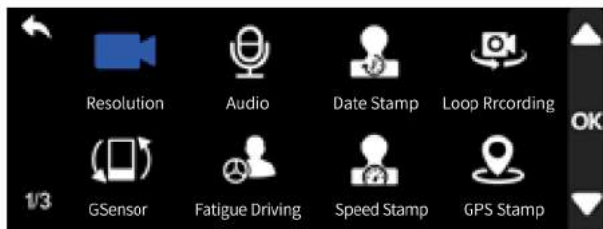

- [Resolution]: 4 modes resolution setting
2160P,1440P, front 2160P + rear 1080P, front 1440P + rear 1080P
- [Audio]: Sound recording on / off
- [Date Stamp]: Date stamp on / off
- [Loop Rrcording]: 1/ 3 / 5 min
- [GSensor]: Off / low / medium / high
- [Fatigue Driving]: Off /1H / 2H / 3H/ 4H
A reminder will be made when drive for 1H / 2H / 3H/ 4H continuously.
- [Speed Stamp]: Speed stamp on / off
- [GPS Stamp]: GPS stamp on / off

About the Setting Menu

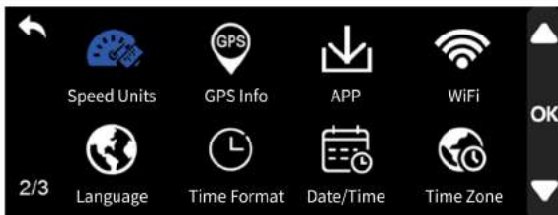

- [Speed Units]: KMH / MPH
- [GPS Info]: Check GPS status
- [APP]: QR code to download the APP
- [WiFi]: WiFi on / off
- [Language]: Languages Setting
- [Time Format]: 12H / 24H
- [Date/Time]: Date / time
- [Time Zone]: The world time standard



- [Frequency]: 50HZ/60HZ
- [ClickTone]: ON/OFF
- [ScreenSaver]: OFF/10S/30S/2Min
- [Parking Monitoring]: Requires hardwire kit (sold separately)
- ※ Does not work without hardwire kit
- [Format]: Delete the data on the memory card and initialize the memory card
- [Default Setting]: Restore to factory default
- [Version]: Displays the version

Parking Monitoring Mode (Optional)

After installation of dedicated hardwire kit (Separately sold) and connected, you can set the parking monitoring functions.

● [OFF]:

The default setting is OFF.

● [G Sensor]:

When select the G-sensor mode, set the G-sensor on menu among high, middle or low, the dash cam will start recording automatically when there's collision or vibration in parking mode.

● [Time-lapse recording 12H / Time-lapse recording 24H / Time-lapse recording 48H]:

When select the Time-lapses mode, and set lapse time between 12hour, 24hour or 48hour. The dash cam will record 1 fps per second, it's extremely saving power and capacity. With battery drain protection, you don't need worry about drain out car battery.

※When playing a time-lapse video, you can [slow] it to achieve the normal playback effect.

FAQ

Please check out contents below. If the problem persists after confirmation, please contact your dealer or customer support.

Problem	Reason	Solution
Dash cam can not turn on	● There is a possibility that the cigar adapter is not connected properly.	● Remove the cigar adapter and then reconnect it. Also, make sure that it is securely inserted into the cigar socket.
	● Are you using a branched socket?	● Connecting the cigar adapter to a branched socket may cause fire, or malfunction.
	● Are you using the included cigar adapter?	● Do not use any power source other than the included cigar adapter. It may cause fire, electric shock or malfunction.
	● The temperature environment in which this machine can be used may not be available.	● This dash cam can be used with "-20°C to +70°C".
Malfunction	● The system of this machine may be malfunctioning.	● Press the reset button.
There is no file that should have been recorded	● When the storage area of the microSD card reaches the upper limit, the continuous recording file is overwritten from the oldest file.	● If you want to keep the files, we recommend that you back them up regularly.
May restart	● If you connect or disconnect each cable while the power is on, the main body may restart or turn off.	● Do not connect or disconnect the cable while the power is on. It may cause unexpected operation or malfunction.
Can't record	● Is the microSD card inserted in the main body?	● Make sure that the microSD card is inserted in the main body.
	● Is there a microSD card read error?	● Format the microSD card. If formatting does not help, try another microSD card. Alternatively, insert or remove the microSD card again.
Frequent emergency recordings	● The G sensor sensitivity setting may not be correct.	● Change the setting from "G sensor" in the setting menu.
GPS cannot be received	● Are you driving in a place where GPS signals are difficult to receive?	● It may be difficult to receive GPS signals in tunnels or in valleys of buildings.
	● Isn't this dash cam just started?	● It may be difficult to receive GPS signal immediately after starting this unit. Check again after a while.
	● Isn't it an in-vehicle environment where the built-in GPS cannot be received?	● Depending on the model, GPS may be difficult to receive. ● Purchase an optional GPS unit.

FAQ

Problem	Reason	Solution
SD card error occurs	<ul style="list-style-type: none"> ● Do you format the SD card regularly? ● Is the SD card inserted correctly? ● The SD card may be damaged. ● There may be a problem with the SD card. 	<ul style="list-style-type: none"> ● Format the SD card. ● Insert the SD card correctly. ● Replace the SD card. ● Format the SD card on your computer. ● Restart dash cam. ※ Please note that formatting the card will erase the saved data.
Cannot format	<ul style="list-style-type: none"> ● There may be a problem with the SD card. 	<ul style="list-style-type: none"> ● Format the SD card on your computer. ● Replace the SD card. ※ Please note that formatting the card will erase the saved data.
Screen flickers	<ul style="list-style-type: none"> ● Power supply may be unstable. 	<ul style="list-style-type: none"> ● Use the included cigar power adapter. ● If you are using a branched cigar socket, insert it directly into the vehicle's cigar socket.
	<ul style="list-style-type: none"> ● The connection of each cable may not be connected correctly. 	<ul style="list-style-type: none"> ● Review the connection of each cable.
Rear camera does not display	<ul style="list-style-type: none"> ● The connection of each cable may not be connected correctly. 	<ul style="list-style-type: none"> ● Is the rear camera connected? ● Review the connection of each cable.

Safety Instructions

Please read this manual carefully before operation and keep it for future reference. It will be helpful and avoid safety issues.

WARNING	Do not disassemble or modify this product. Otherwise, it may cause a fire, electric shock or malfunction.
	Keep small accessories out of the reach of children.
	Be sure to use accessories and designated parts. Using non-designated parts may damage the equipment or cause fire, electric shock, or malfunction.
	If this product is damaged or malfunctions, stop using it immediately and consult your dealer. Continued use may cause fire, electric shock or vehicle failure.
	If it interferes with driving, please do not install it. This may cause an accident.
	Be sure to use a fuse of the specified capacity. Using a fuse exceeding the specified capacity may cause fire, smoke, fire or malfunction. Ask the store where you purchased the product to replace or repair the fuse. (Fuse: 2A)
CAUTION	Do not install in places exposed to water, humidity or dust. Otherwise, it may cause a fire, electric shock or malfunction.
	Do not allow water or other objects to enter the inside of the device. Otherwise, it may cause a fire, electric shock or malfunction.
	Regularly check loose screws and loose double-sided tape. Driving obstacles may causes of accidents.

DO NOT ATTEMPT TO SERVICE THE UNIT BY YOURSELF! THE DEVICE WILL BECOME HOT DURING OPERATION. PLEASE AVOID TOUCHING THE LENS DIRECTLY DURING OR AFTER USE.

Product Specifications

Model	F7N
Display	3.16 inch IPS
Power	12V/24V
Aperture	1.5
Battery	Super capacitor
Video Format	Video:MP4 Still image:JPG
Loop recording	1/3/5mins
Recording method	Nomal recording / Emergency recording
Screen View	Front + Rear view / Front view / Rear view
Resolution	Front 3840*2160P, Front 2560*1440P, Front 2160P+Rear 1080P, Front 1440 P+Rear1080P
GPS	Yes
G-sensor	3 Axis G-sensor
Audio	Support sound recording and playback
Micro SD card	MicroSD 8GB-256GB
Record photo reproduction method	Main body display / Computer / Smartphone
Temperature	-20°C~70°C
Warranty period	1 Year

Warranty&Support:

12 months warranty period

If you have any questions about the product, please feel free to contact us. Inquiries will be answered within 6-24 hours of the working day.



LINE



WhatsApp

E-mail: redtiger.cam@gmail.com



Made in China

FCC Warning Statement

Changes or modifications not expressly approved by the party responsible for compliance could void the user's authority to operate the equipment. This equipment has been tested and found to comply with the limits for a Class B digital device, pursuant to Part 15 of the FCC Rules. These limits are designed to provide reasonable protection against harmful interference in a residential installation. This equipment generates uses and can radiate radio frequency energy and, if not installed and used in accordance with the instructions, may cause harmful interference to radio communications.

However, there is no guarantee that interference will not occur in a particular installation. If this equipment does cause harmful interference to radio or television reception, which can be determined by turning the equipment off and on, the user is encouraged to try to correct the interference by one or more of the following measures:

- - Reorient or relocate the receiving antenna.
- - Increase the separation between the equipment and receiver.
- - Connect the equipment into an outlet on a circuit different from that to which the receiver is connected.
- - Consult the dealer or an experienced radio/TV technician for help.

This device complies with part 15 of the FCC Rules. Operation is subject to the following two conditions: (1) This device may not cause harmful interference, and (2) this device must accept any interference received, including interference that may cause undesired operation.

RF Exposure Statement

To maintain compliance with FCC's RF Exposure guidelines, This equipment should be installed and operated with minimum distance of 20cm the radiator your body. This device and its antenna(s) must not be co-located or operation in conjunction with any other antenna or transmitter.