

Visit dashcamtalk.com for the latest firmware and owners forum.

FULL HD BLACK BOX

Vehicle Video Recorder

FINE Vu



CR-500HD User Manual

FINE DIGITAL

Thank you for choosing the Finevu Car black box.

Before using the product, please read this manual carefully.

Finedigital has an on-going policy of upgrading its products and it may be possible that information in this document is not up-to-date. Please visit the Finevu website (www.finevu.com) for current updates and the latest information.

Copyright and Trademark

No part of this document can be copied or reproduced in any form without written consent from Finedigital. Finevu is a trademark of Finedigital Inc. and may not be used without the express permission of Finedigital. All trade names and trademarks are the properties of their respective companies.

Certifications

This product has been tested and found to comply with the limits for a Class A digital device pursuant to Part 15 of the FCC Rules. These limits are designed to provide reasonable protection against harmful interference when the equipment is operated in a commercial environment. This product generates, uses, and can radiate radio frequency energy and, if not installed and used in accordance with the instruction manual, may cause harmful interference with radio communications.

Contents

| | | |
|---|--|----|
| Safety and Precautions | Warning | 4 |
| | Caution..... | 5 |
| | Notes..... | 5 |
| | Features | 6 |
| Components and names | Components | 7 |
| | Optional Accessories..... | 8 |
| | Names..... | 9 |
| Installation | Finding an installation location...10 | |
| | Inserting micro SD card.....10 | |
| | Installation | 11 |
| Using the product | Recording videos and taking pictures | 12 |
| | Viewing videos and pictures | 17 |
| Settings | Memory management | 21 |
| | Memory map | 22 |
| | Connecting the black box to a PC | 23 |
| | Setup program | 24 |
| | Advanced settings | 25 |
| Voice Recording, SD Card Format, and Alarm Sound | Recording..... | 26 |
| | SD Card Format..... | 26 |
| | Status alarms..... | 27 |
| Management | Firmware upgrade..... | 28 |
| | Cleaning and storage..... | 29 |
| Troubleshooting | | 30 |
| Specifications | | 32 |
| How to install and use the FineVu Player | | 33 |

Safety and Precautions



WARNING

Breaching the following precautions may result in serious personal injury or even death.

Power

- Do not use a damaged or modified power cable. Doing so may cause explosion or fire, and may result in personal injury or damage to the vehicle.
- Only use this product within the rated voltage. Failing to do so may cause explosion or fire, and result in personal injury or damage to the vehicle.
- Do not connect the power cable arbitrarily. Doing so may result in fire or product failure.

Installation

- Do not use this product in a place where there is a danger of exposure to high humidity or flammable liquids or gases. Doing so may result in explosion or fire.
- Do not leave the black box in a place with a high temperature, such as in the closed vehicle or in direct sunlight. Doing so may result in fire or product failure.
- Ensure that you install the product in a position where it won't obstruct your view. Doing so could cause a car accident.

Use

- Plug the USB and video cables in properly. Failure to do so may result in fire or product failure.
- Do not allow the product to come into contact with flammable and explosive liquids or gases. Doing so may result in explosion or fire.
- Do not allow metal or flammable substances to get into the memory card slot or cord outlet of your black box. This may result in electric shock or fire.
- Do not operate the product with wet hands. This may result in electric shock.
- Do not leave the product or its accessories within reach of children, since they may swallow small components. Doing so may result in serious personal injury or death.
- Do not cover the black box with a cloth or a blanket while in use. Continuous heating may cause fire or product failure.
- Do not operate the black box while driving. It could cause a car accident.



CAUTION

Breaching the following precautions may result in personal injury or property damage.

Installation

- Do not connect the uninterrupted power supply arbitrarily. It may result in vehicular or product failure. Make sure to consult an expert for installation.

Use

- Do not apply excessive force to the black box and the lens. Doing so may result in product failure.
- Do not use an awl or a sharp object when using the black box. Doing so may result in product failure.
- Do not spray water or wax directly onto this product. Doing so may result in electric shock or product failure.
- When you use the black box for an extended period of time, the internal heat it generates may cause your skin to burn at the contact area if touched.
- Do not disassemble or modify this product arbitrarily. Doing so may cause breakage of the product or data loss. Consult the A/S center for inspection and repair of the product.

Management

- Do not leave the product or its accessories within reach of a pet. Foreign objects could get into the inside of the product, and cause an explosion or product failure.
- Disconnect the power cable if you are not using the product for an extended period of time. Failure to do so may result in fire or product failure.
- Do not move the product while the cigar jack cord or cables are plugged in. This may result in fire or electric shock.

Notes

- The specifications and user manual of this product are subject to change without notice to improve its performance.

Features

Clear video quality

- 16:9 widescreen and full HD video recording
- Still image capture
- 2 megapixels digital CMOS Sensor
- High resolution, 119° horizontal wide angle camera lens
- Adjust the brightness of the video in 5 levels at night

Various recording modes

- Normal recording while driving
- Shock recording while driving
- Shock recording while parking
- Motion detection recording while parking
- Recording with the built-in/external battery
- Emergency recording
- Taking pictures

Recording while parking

- Detection feature to prevent the vehicle battery from discharging

Voice recording and audio output

- Vivid audio recording with a high sensitivity microphone
- Clear sound output with a speaker

Built-in battery

- Even when the ignition is turned off, the built-in battery enables the black box to record video (max. 4 mins)

- The built-in battery supplies power to the RTC (Real Time Clock): You can set the system time with the setup program after connecting the black box to the PC.

Video display for adjusting the recording angle

- Use this feature when adjusting the recording angle after initial installation.

Easy installation

- Always recording in the correct direction by automatically changing the image orientation no matter where it is installed
- Easy removal of the black box from the mount

Quick and easy connection to the PC

- Direct connection with the black box via the USB port
- Auto recognition of USB storage devices
- Setup program provided (for Windows only)
- Play video with a normal video player

Expand memory

- You can easily expand the memory using an external memory card (16 GB/ 32 GB micro SD)

Memory management

- You can allocate memory space for each recording mode.

Components and names

Components

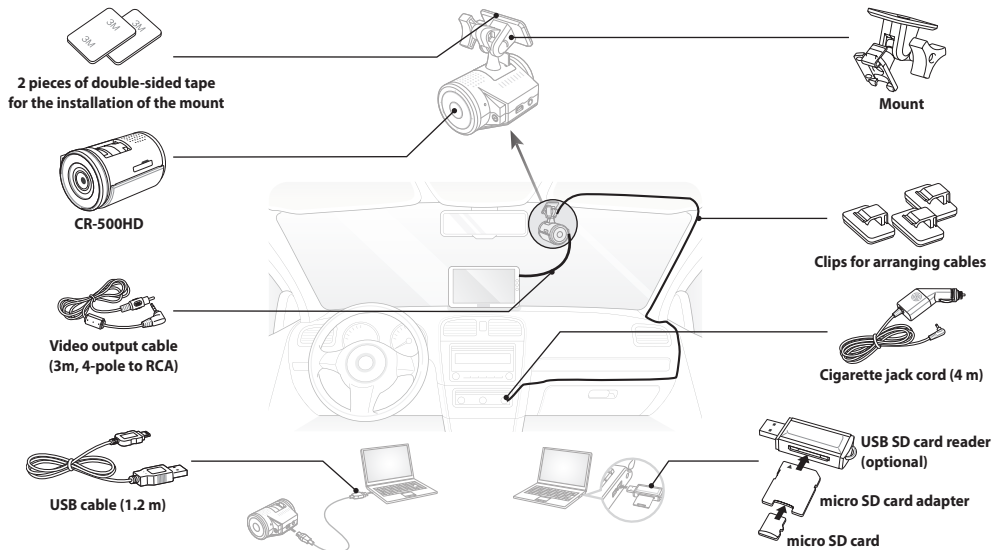

× The components of this product are subject to change without notice in order to improve its performance.

Optional Accessories



USB SD card reader

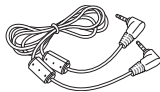

**Video output cable
4-pole to 4-pole**

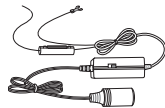

Power adapter

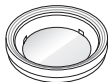

Polarizing filter



**External USB
battery pack**

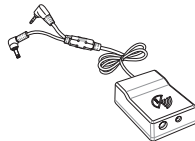

GPS

Note

All accessories are available from the store where you purchased the product.

Names

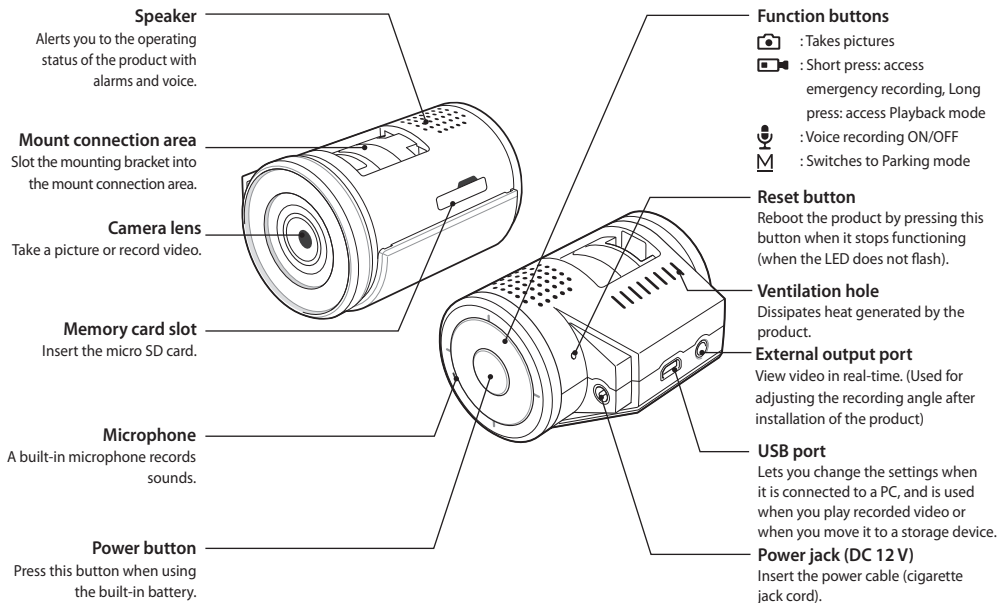

Installation

Finding an installation location

- We recommend that the product is installed on the front windshield, either to the left or the right of the rear view mirror, and in a position that doesn't prevent you from adjusting the position of the mirror.
- You can also install it on the dashboard.

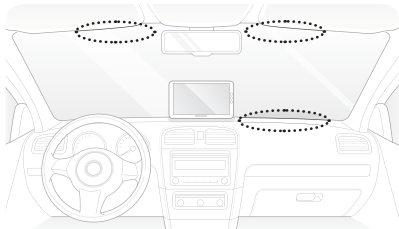

- You can also install it on the rear windshield.



Note

Install the product in a position where it won't obstruct the driver's view.

Inserting micro SD card

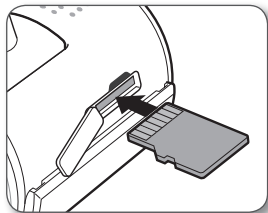

Note

Insert the micro SD card with the golden contact area facing upwards.

Installation

Before commencing installation, plan where you will be routing the cable so that it is secure, safe, and that the cable is long enough.

(Optional) When viewing footage from the camera via a navigation device, connect the video output on the camera to the video input on the navigation device.

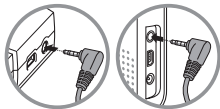

Plug the cigarette jack cord into the cigarette jack.

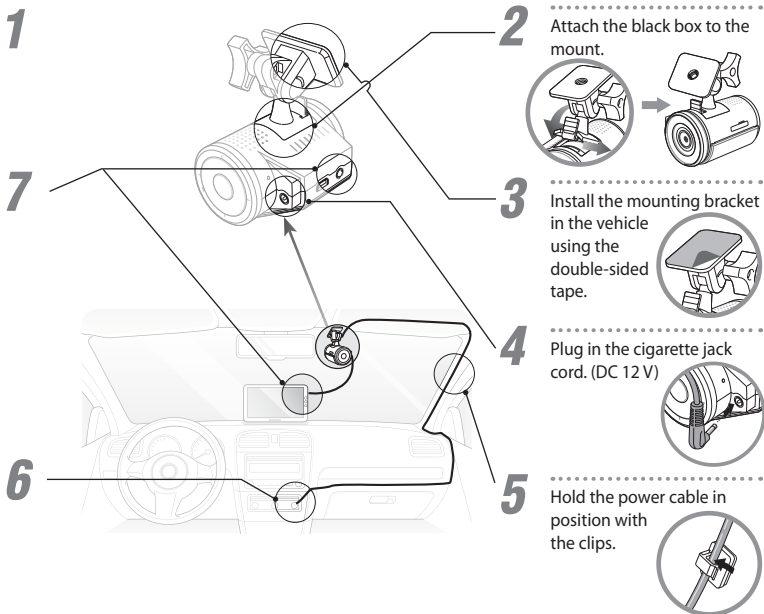

Using the product

Recording videos and taking pictures

Basic operation

Note



















color indicates that the LED is blinking.

| Mode | LED Buttons | | | | | Description |
|---------|-------------|-------|-----|-------|-------|---|
| | | | | | | |
| Booting | White | White | Red | Green | Green | Booting is completed within 30 seconds of power-up. |

Recording while driving

| Mode | LED Buttons | | | | | Description |
|------------------|-------------|--|-----|-------|-------|---|
| | | | | | | |
| Normal recording | | | Red | Green | Green | <ul style="list-style-type: none">When booting is complete, the Normal Recording mode starts.The recorded video is stored in the normal folder on the memory card. |
| Shock recording | | | Red | Green | Green | <ul style="list-style-type: none">The Normal Recording mode switches to the Shock Recording mode when a shock is detected.Records video 5 seconds before and 35 seconds after impact (in total 40 seconds), in the event folder.The video recorded in Normal Recording mode before impact will also be saved as _normal_to_event in the event folder. <p>Note You can set the shock sensitivity.</p> |













Recording while driving

| Mode | LED Buttons | | | | | Description |
|----------------------------|---|---|---|---|---|--|
| |  |  |  |  |  | |
| Emergency recording |  |  | Red | Green | Green | <ul style="list-style-type: none"> If you press the  button in Normal Recording mode, the mode changes to Emergency Recording mode. You can record video for max. 1 minute, and the recorded video will be saved in the camcorder folder on the memory card. |
| Taking pictures |  |  | Red | Green | Green | <ul style="list-style-type: none"> You can press the  button in Normal Recording mode to take a picture. The picture will be saved in the photo folder on the memory card. <p>Note You can only shoot again once 3 seconds have elapsed.</p> |
| Auto recording |  |  | Red | Green | Off | <ul style="list-style-type: none"> Video records for 30 seconds when turning off the ignition. The recorded video is saved in the event folder on the memory card. When recording is complete, the black box switches to the Standby mode. |
| Standby |  |  | Red | Green | Off | <ul style="list-style-type: none"> When auto recording is complete, the black box switches to the Standby mode. The black box goes on standby for 30 seconds and then turns off automatically. Or, when you press and hold down the  button for 5 seconds, the black box turns off. |

Note

- If the voltage of the built-in battery is low, the black box may turn off without a standby time of 30 seconds.















Recording while parking

| Mode | LED Buttons | | | | | Description |
|-----------------------------------|---|---|---|---|---|--|
| |  |  |  |  |  | |
| Parking | Off | Off | Red | Green |  | <ul style="list-style-type: none">If you press and hold down the M button in Normal Recording mode or if there is no movement of the vehicle for 10 minutes, the mode automatically changes to the Parking mode.If you press the M button once again, the mode changes to Normal Recording mode. |
| Shock recording |  |  | Red | Green |  | <ul style="list-style-type: none">If an external impact to the vehicle is detected in Parking mode, the black box will start to record video. The recorded video will be saved as _parking in the event folder on the memory card. |
| Motion detection recording |  |  | Red | Green |  | <ul style="list-style-type: none">If the black box detects a moving object in Parking mode, it records video.The recorded video will be saved as _motion in the event folder on the memory card. |

Note

- When you use Parking mode, you need to use the uninterrupted power supply. With the exception of certain vehicle types, the uninterrupted power supply should be connected separately. Please consult an expert.
- Parking mode only records video when there is external impact to the vehicle or if motion is detected.
- When you operate Parking Recording mode for an extended period of time using the vehicle's uninterrupted power, the black box stops working if the voltage of the vehicle battery goes down below a certain voltage level so as to prevent the vehicle battery from discharging.
- Do not cut the enclosed original cigar jack cord. Doing so may result in product malfunction.

Recording with built-in battery













| Mode | LED Buttons | | | | | Description |
|----------------------------|---|---|---|---|---|---|
| |  |  |  |  |  | |
| Booting | White | White | Red | Green | Green | <ul style="list-style-type: none"> If you press and hold down the  button for 2 seconds, booting will be completed within 30 seconds. |
| Emergency recording |  |  | Red | Green | Off | <ul style="list-style-type: none"> If you press the  button in Standby mode, the mode changes to Emergency Recording mode. You can record video for max. 1 minute, and the recorded video will be saved in the camcorder folder on the memory card. When recording is complete, the black box switches to the Standby mode. |
| Taking pictures |  |  | Red | Green | Off | <ul style="list-style-type: none"> You can press the  button in Standby mode to take a picture. The picture is saved in the photo folder on the memory card. <p>Note You can only shoot again once 3 seconds have elapsed.</p> |
| Standby |  |  | Red | Green | Off | <ul style="list-style-type: none"> After booting is completed, the black box goes on Standby mode. The Standby mode lasts for 30 seconds and then turn off automatically. Or, when you press and hold down the  button for 5 seconds, the black box turns off. |

Note

- If the voltage of the built-in battery is low, the black box may turn off without a standby time of 30 seconds.

Using the product

Recording with external USB power (external battery)

| Mode | LED Buttons | | | | | Description |
|----------------------------|--|--|---|---|---|---|
| |  |  |  |  |  | |
| Booting | White | White | Red | Green | Green | <ul style="list-style-type: none">Booting is completed within 30 seconds of power-up. |
| Normal recording |  Blue |  Blue | Red | Green | Off | <ul style="list-style-type: none">If the external power is supplied to the black box through the USB port, booting will be complete and then the black box will switch to the Normal Recording mode.The recorded video is stored in the normal folder on the memory card. |
| Emergency recording |  Red |  Red | Red | Green | Off | <ul style="list-style-type: none">If you press the  button in Normal Recording mode, the mode changes to Emergency Recording mode.You can record video for max. 1 minute, and the recorded video will be saved in the camcorder folder on the memory card.When recording is complete, the black box switches to the Normal Recording mode. |
| Taking pictures |  Red |  Red | Red | Green | Off | <ul style="list-style-type: none">You can press the  button in Normal Recording mode to take a picture.The picture is saved in the photo folder on the memory card. <p>Note</p> <p>You can only shoot again once 3 seconds have elapsed.</p> |

Note

- The Parking mode is not supported when using the external USB power.
- Shock recording is not supported when using the external USB power.
- If the external USB power is supplied by a PC, recording is not available.

Viewing videos and pictures

Viewing on PC (connecting the black box)

- 1 Connect the black box to the PC with the USB cable.

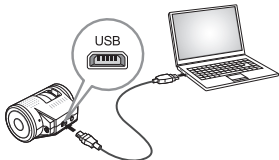

- 2 After booting is complete, the black box switches to USB mode and is executed as a removable disk.

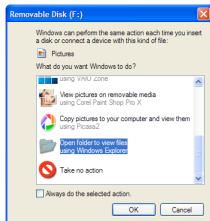

- 3 When you click '**Open folder to view files using Windows Explorer**', the folders containing videos and pictures will appear.

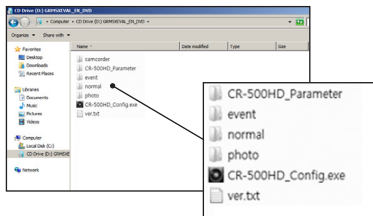

- 4 You can play the recorded videos and view the pictures saved in each folder.

Note

- Each folder contains:
camcorder: Emergency recording,
event: Shock recording,
normal: Normal recording,
photo: Pictures
- Please make sure that you back up important videos and pictures on your PC or other storage devices.

Viewing on PC (memory card)

- 1 Remove the micro SD card from the black box and place it in the micro SD adapter. Use the memory card reader for connection with a PC.



- 2 When you connect the micro SDHC card to the PC, it is executed as a removable disk.

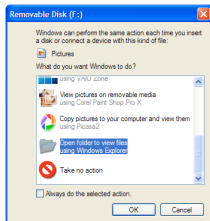

- 3 When you click 'Open folder to view files using Windows Explorer', the folders containing videos and pictures will appear.

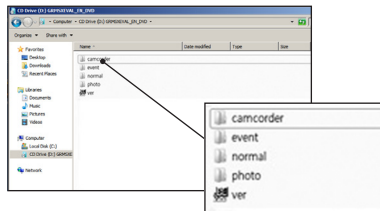

- 4 You can play the recorded videos and view the pictures saved in each folder.







Note

- Each folder contains:
 - camcorder: Emergency recording,
 - event: Shock recording,
 - normal: Normal recording,
 - photo: Pictures
- Please make sure that you back up important videos and pictures on your PC or other storage devices.

Viewing on navigation device

1
Connect the video output cable from the black box to the navigation device.

2
Press and hold down the  button for 5 seconds to switch to the Playback mode.

| Mode | LED Buttons | | | | |
|----------|---|---|---|---|---|
| |  |  |  |  |  |
| Playback |  Green |  Green | Red | Off | Off |

3
Recently recorded video files play automatically 3 or 4 seconds after switching to Playback mode.

4
All video files are played in order from the latest files to the oldest ones, regardless of the shooting modes. (All video files in the normal, event and camcorder folders are played.)

5
The simple menu displays along with the video on the external input screen of the navigation device.

Note

- Audio is not supported when playing video on the navigation device.
- Use this feature when adjusting the recording angle after initial installation.

Using the product

6 Playback screen

You can play the recorded video on the navigation device as below.

The diagram shows a dashcam's playback screen. At the top, there is a black control bar with four buttons: 'PREVIOUS' (with a left arrow icon), 'NEXT' (with an 'M' icon), 'REPEAT' (with a circular arrow icon), and 'PRESS&HOLD EXIT' (with a square and right arrow icon). Below this bar is a video feed of a road with cars. At the bottom of the screen, there are two data overlays. The left overlay shows 'BATT' (battery voltage) and 'VOLT' (vehicle voltage). The right overlay shows 'ACCEL' (acceleration sensor value) and 'DATE/TIME' (recorded date/time).

Previous file
If you press the  button while playing a recorded video, the **previous file** will play automatically.

Next file
If you press the  button while playing a recorded video, the **next file** will play automatically.

Repeat the current file
If you press the  button, the **current video** will replay from the beginning.

Exit
If you press and hold down the  button for 3 seconds, the Playback mode will stop. The black box then reboots and switches to Normal Recording mode.

Built-in battery voltage

Vehicle voltage

Acceleration sensor value

Settings information

Recorded date/time

Settings

Before configuring the settings, find out about the video range of each recording mode and the number of files to be saved in the memory.

Memory management

The start and end recording times differ for each recording mode, depending on the resolution of the video.

| Mode | | Storage time for each recording mode | | | | Folder name |
|---|----------------------------|---|-------|--|-------|-------------|
| Resolution | | 1080 P | 900 P | 720 P | 540 P | |
| Normal recording | | 3 minutes in total | | | | normal |
| Shock recording | | 5 seconds before and 35 seconds after (40 seconds in total) | | 10 seconds before and 30 seconds after (40 seconds in total) | | event |
| Recording while parking | Shock recording | | | | | |
| | Motion detection recording | | | | | |
| Auto recording when the ignition is off | | 5 seconds before and 25 seconds after (30 seconds in total) | | 10 seconds before and 20 seconds after (30 seconds in total) | | |
| Emergency recording | | 5 seconds before and 55 seconds after (1 minute in total) | | 10 seconds before and 50 seconds after (1 minute in total) | | camcorder |

Note

- In Shock Recording mode, the black box records video for up to 2 minutes for a series of events.

Memory map

The maximum **recording time** and **number of files** for each recording mode are as follows:

| Memory size | Category | Normal recording | Shock/Motion detection recording | Emergency recording | Taking pictures | Remarks |
|------------------------------------|-------------------|------------------|----------------------------------|---------------------|-----------------|--|
| 16GB Max. 3 hrs 30 mins | Max. size | 7.8 GB | 6.0 GB | 0.6 GB | 0.1 GB | 1080p 30fps, H.264 encoding / 10Mbps (Ultra High Definition) |
| | Max. storage time | 114 mins | 88 mins | 8 mins | - | |
| | Max. files | 38 files | 150 files | 8 files | 100 - 200 files | |
| 32 GB Max. 6 hrs 50 mins | Max. size | 15.0 GB | 12.0 GB | 0.6 GB | 0.1 GB | |
| | Max. storage time | 222 mins | 175 mins | 8 mins | - | |
| | Max. files | 74 files | 300 files | 8 files | 100 - 200 files | |

Note

- When there is insufficient space for recording, the old video files are deleted and the new video files are stored.
- Format your memory card at least once a month with FAT32 filesystem to prevent memory card error.

Connecting the black box to a PC

- 1
Connect the black box to the PC with the USB cable.

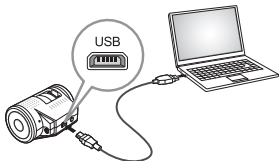

- 2
After booting is complete, the black box switches to USB mode and is executed as a removable disk.

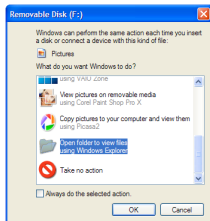

- 3
When you click '**Open folder to view files using Windows Explorer**', a folder with the executable file will be displayed as shown in the figure.

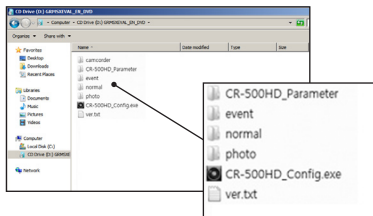

- 4
When you execute '**CR-500HD_Config.exe**', the '**CR-500HD_Settings.exe**' setup program is copied onto the desktop and then executed.



Settings

Setup program

The screenshot shows the 'Setup Program' window with the following settings and callouts:

- Information display:** Displays the model name and the firmware version. (Model: CR-500HD, Firmware: 1.00.100)
- Recording Mode:** Allows you to set a recording mode. (Selected: 1920*1080 1080p Full HD; Other options: 1600*900 900p HD+, 1280*720 720p HD, 960*540 540p qHD)
- Shock Sensitivity in Driving Mode:** Adjust the shock sensitivity in Driving mode. (Options: OFF, Low, Normal, High)
- Auto Parking Mode:** Set the method for accessing Parking mode to Manual or Auto (auto accessing 10 minutes after parking). (Options: ON, OFF)
- Shock Sensitivity in Parking Mode:** Adjust the shock sensitivity in Parking mode. (Options: Low, Normal, High)
- Motion Detection in Parking Mode:** Set the motion detection value in Parking mode. (Options: OFF, Low, High)
- Nighttime Brightness:** Adjust the brightness of the video at night in low lighting conditions. (Options: Normal, Medium, Bright)
- Speaker Volume:** Set the speaker volume and enable/disable the voice recording feature. (Options: OFF, 1, 2, 3, 4)
- Voice Recording:** (Options: ON, OFF)
- System Time:** Displays the system time of the PC. (2012-10-12 05: 23: 43)
- Reset:** Initializes the set values.
- Advanced Settings:** Set the advanced settings. Refer to next page.
- OK:** Changed values are applied to the black box. (Make sure to reboot the product to apply the changes.)

Advanced settings











The screenshot shows the 'Advanced Settings' menu with the following options and callouts:

- Video Quality**: Set the video resolution (Ultra High/ High/ Standard).
- Video Sharpness**: Set the sharpness of the recorded video.
- Recording fps in Driving Mode**: Set the recording frames per second.
- Recording fps in Parking Mode**: Set the frames per second for video in Parking/Motion Detection Recording mode.
- Video Rotation**: Set the Rotation in which the black box is installed.
- Video Recording in Black and White (Nighttime)**: Switches video to black and white at night in Parking mode.
- Video Out Image Flip**: Flip the video output image. (Use this feature when you view rear camera footage via the navigation device.)
- Video Out Format**: Set the video format NTSC or PAL.
- Vehicle Speed (GPS Option)**: Set the speedometer by GPS.
- Memory Allocation**: Set the memory allocation ratio for Normal recording, and Shock/ Parking/Motion Detection recording.

The Memory Allocation slider is set to approximately 45% and is divided into three sections: Driving Mode Portion (0% to 40%), Event Portion (40% to 80%), and Dedicated (80% to 100%).

Voice Recording, SD Card Format, and Alarm Sound





Recording

| Status | LED Buttons | | | | | Operation |
|---------------------|--|--|---|---|---|--|
| |  |  |  |  |  | |
| Voice Recording ON |  Blue |  Blue | Red | Green | Green | <ul style="list-style-type: none">When voice recording is OFF, press the  button. An alarm will sound and voice recording will start. |
| Voice Recording OFF |  Blue |  Blue | Red | Off | Green | <ul style="list-style-type: none">When voice recording is ON, press the  button. An alarm will sound and voice recording will stop. |

Note

The default setting is **Voice Recording ON**.

SD Card Format

- 1 Press and hold the  button and supply power to the black box. Hold down the  button for about 7 seconds.
- 2 When 7 seconds have passed, the LEDs of the  and  buttons will blink for 2 seconds in white.
- 3 After booting, formatting will be performed with an alarm sound, "Beep~ Beep~ Beep~". (The LED will light in yellow during formatting.)
- 4 When formatting is complete, recording starts after rebooting.

Note

- Video images will be deleted after the SD card is formatted, and cannot be restored. Therefore, be sure to copy important video images to your PC or personal mobile storage device.

Status alarms

| Status | Alarm |
|--|--------------------------------------|
| Booting sound & Start recording | "Ding-Dong~ Video recording starts." |
| Emergency recording | "Cha-Re-Rook" (sound of projector) |
| Removing power | "Dong-Ding~" |
| Memory recognition error sound | "Beep~ Check your memory card." |
| Recording starts in Parking mode | "Ding-Dong~ Parking mode." |
| Recording in Shock mode | "Beep~" |
| USB mode | "Ding-Dong~ USB mode." |
| Shooting | "Click~" (sound of shutter) |
| Finishing sound | "Dong-Ding~" |
| Playback mode for recorded video | "Ding-Dong~ Video playback mode." |
| Turning off MIC | "Ding~" |

| Status | Alarm |
|-----------------------------------|--|
| Turning on MIC | "Ding-Dong~" |
| Reset time* | "Beep~ Please check the time setting." |
| Formatting Sound | "Beep Beep~, Beep Beep~, Beep Beep~" |
| GPS Sound | "GPS is received." |
| Status alarm 1 | "Ding-Dong~ Normal recording mode." |
| Status alarm 2 | "Ding-Dong~ Parking mode." |
| Status alarm 3 | "Ding-Dong~ Emergency recording mode." |
| Status alarm 4 | "Ding-Dong~ Video playback mode." |
| Switch to Normal recording | "Ding-Dong~" |

* If a system time error occurs, an alarm will sound whenever you reboot the black box. Connect the black box to your PC and set the system time again in the setup program.

Management

Firmware upgrade

1
Download the latest firmware from the website.

2
Remove the micro SD card from the black box and place it in the micro SD adapter. Use the memory card reader for connection with a PC.



3
When you connect the micro SD card to a PC, it is executed as a removable disk. (It is recommended that you format the memory card prior to the firmware upgrade.)

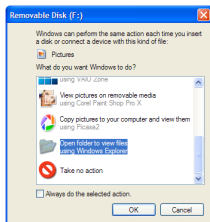

4
Unzip the downloaded firmware and copy it to the root directory of the memory card.

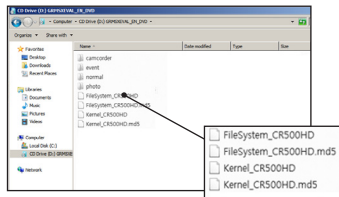

5
When you insert the micro SD card into the black box and turn the power on, 4 LEDs will flash and the upgrade will start.

Note

- The upgrade takes approximately 3 minutes. When the upgrade is complete, the firmware file will automatically be deleted.
- Prior to upgrade, it is recommended that you back up all important files on the micro SD card.

Cleaning and storage

Cleaning

- If there is a foreign object on the lens, wipe it down with a soft cloth.
 - To obtain high quality video, do not touch the lens with your hands or allow it to make contact with other objects.
- Clean the black box with a tissue or a dry cloth if there is a foreign object on its exterior.
- Do not attempt to disassemble the black box and take out a foreign object using a tool if it is inside the black box. Contact the A/S center.

Storage

- If you are not using the black box, remove it from your vehicle and keep it indoors.
- Make sure to disconnect the power while storing it.
- Keep the black box enclosed if possible and avoid damp places.
- Remove the memory card to prevent it from degrading while storing the black box.

Troubleshooting

The black box does not turn on.

- Check if the power (cigarette jack cord) is connected.
- If the product is not working at all, press the RESET button with the tip of a clip. (Resetting only blocks power, and thus does not affect the product or the stored video.)

The buttons are not working.

- Check if the black box is in the video recording state after booting.
- If the buttons are not working in the recording state, request after sales service.

The black box does not boot up.

- Check if the cigarette jack cord is the original one.
- Check if the power LED of the cigar jack cord is on.
- Check if the micro SD memory card has been inserted into the black box properly.
- Check if the external memory card format is FAT32. (NTFS or exFAT are not recognized.)
- Check if the external memory card is faulty or not an original component.

Bootng is complete, but there is no sound.

- On the Setup Program screen, check if the alarm volume is set to its lowest.
- If there is still no sound after adjusting the volume, request after sales service.

Recorded video does not play.

- Video may not play depending on the characteristics of the video player.
- If the problem still persists, request after sales service.

My PC does not recognize the black box.

- If the black box does not turn on when connected to the PC or does not switch to USB mode, press the RESET button.
- If the connection often disconnects or becomes unstable, connect the black box directly to a USB port on the PC without using a USB hub. Connection through a USB hub may not provide stable power to the black box.

The black box is recognized on the PC USB, but is disconnected.

- Connect the black box to the USB port of the PC main board if possible.
- Remove any other USB devices connected to the PC. Connect the black box only or connect it to the USB host card.
- Check if the same problem occurs on other PCs. If so, request after sales service.

The black box is connected to the USB port of a navigation device, but it is not working.

- Recording is unavailable with power through the USB port of a navigation device. It is, however, recognized as a USB movable disk.

There is no recorded video image.

- Check if the black box booted properly.
- If only audio plays without a video image display, request after sales service.

I would like to change the external memory card.

- You can use any original micro SD card with the same specification as the card supplied. (or a card which does not exceed the recommended limit defined in the Specification section below.)
- The physical characteristics of micro SD cards differ from manufacturer to manufacturer. Some micro SD cards may not be compatible with Finedigital black box.

Specifications

| Item | Specifications | | Remarks |
|---------------------------------------|--|----------------------------|--|
| Model Name | CR-500HD | | |
| Dimensions/ Weight | 39x64x50 mm/ 88 g | | |
| Memory capacity | micro SD | 16 GB/ 32 GB | Class 10 or above recommended |
| Recording methods | Normal recording | Supported (1080p 30fps) | Records video in 3 minute intervals. |
| | Shock recording | | Records video 5 seconds before and 35 seconds after impact (40 seconds in total). |
| | Emergency recording | | Records video 5 seconds before and 55 seconds after (1 minute in total). |
| | Recording while parking | | Records video 5 seconds before and 35 seconds after impact or motion detection (40 seconds in total). An additional device needs to be installed in vehicles that do not support uninterrupted power. |
| | Auto recording | | Records video for 30 seconds when turning off the ignition (30 seconds in total). |
| | Still image capturing | | 1920*1080 1280*720 |
| Angle of view | Diagonal 135°/ Horizontal 119°/ Vertical 70° | | |
| Video | 1920x1080 | FULL HD 1080p 30fps | 16:9 WIDE |
| Audio | Built-in microphone | | |
| | Built-in speaker | 8 ohms | |
| Acceleration sensor | 3-Axis acceleration sensor | +2 g/ -2 g | |
| Input power | DC 12 V | | USB 5V supported (external battery) |
| Battery | Built-in Li-Polymer battery | | |
| Power consumption | Max. 2 W | | Max. 3 W when charging |
| Operating/ Storage temperature | Operating temperature: -10°C ~ 60°C / Storage temperature: -20°C ~ 70°C | | |
| Interface | USB 1.1/ 2.0 Mini B type | DC JACK 3.5Φ | |
| Video output | TV/ Navigation device output | | NTSC/PAL |

Visit dashcamtalk.com for the latest firmware and owners forum.

Installing and using FineVu Player

FineVu Player is the software that enables you to play a video recorded by the Finevu car black box.
Download FineVu Player from <http://www.finevu.com> and install it.

Main screen

When you install and then run FineVu Player, the following screen is displayed.

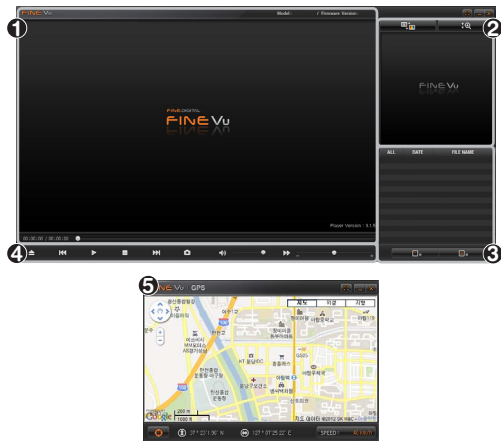

- 1 The main screen where a recorded video is played
- 2 The sub screen where the selected part of the main screen is shown enlarged
- 3 The List screen showing a list of recorded videos
- 4 The Control bar with which you can play and control recorded videos
- 5 The GPS popup displayed when the recorded video contains GPS information (* It is not displayed when there is no GPS information available.)

Visit dashcamtalk.com for the latest firmware and owners forum.

Playing and checking recorded videos

1
Click the Open  button in the control bar.

2
Select a folder containing recorded videos.



3
Select a video file listed in the List screen and then click the Play  button to play the selected video.

| ALL | DATE | FILE NAME |
|---------|------------|-------------------------|
| NORMAL | 2012.08.10 | 17h46m17s_normal_to_... |
| EVENT | 2012.08.10 | 17h46m22s_event.avi |
| NORMAL | 2012.08.10 | 17h46m27s_normal_to_... |
| EVENT | 2012.08.10 | 17h49m21s_event.avi |
| PARKING | 2012.08.10 | 17h49m36s_parking.avi |
| NORMAL | 2012.08.10 | 17h49m55s_normal_to_... |
| EVENT | 2012.08.10 | 17h50m02s_event.avi |

4
Now you can check the scenes being played. You can move around and check the scenes by time using the buttons in the Control bar.

Recommended PC specifications for FineVu Player

| | Minimum | Recommended |
|---------|------------------|--|
| OS | Windows XP SP3 | Windows Vista, 7 |
| HDD | 30 MB | 50 MB or more |
| CPU | Pentium4 3.0 GHz | Intel Dual Core or later / AMD AthlonX2 or later |
| VGA | 128 MB | 512 MB or more |
| RAM | 1 GB | 2 GB or more |
| DirectX | 9.0c | 9.0c |

Limited Warranty

This product is guaranteed against manufacturing defects for one (1) year (six (6) months for battery and accessories) from the original date of purchase. Finedigital's sole obligation in the event of such defects during this period is to repair or replace the defective part or product with a comparable part or product at Finedigital's sole discretion. Except for such replacement, the sale, or other handling of this product is without warranty, condition or other liability even though the defect or loss is caused by negligence or other fault. Damage resulting from use, accident, or normal wear and tear is not covered by this or any warranty. Finedigital assumes no liability for any accident, injury, death, loss, or other claim related to or resulting from the use of this product. In no event shall Finedigital be liable for incidental or consequential damages relating to or resulting from the use of this product or any of its parts.

Finedigital is not liable for the costs of installing and removing the products and its accessories regardless of the warranty period.

Visit dashcamtalk.com for the latest firmware and owners forum.

FINE DIGITAL

www.FineVu.com