

Driving Recorder

• **Welcome:**

Thanks for purchasing this product. Please read the instructions carefully before using this product.

• **FCC Compliance Statement:**

This device complies with Part 15 of the FCC Rules. Operation is subjected to the following two conditions: (1) this device may not cause harmful interference, and (2) this device must accept any interference received, including interference that may cause undesired operation.



This equipment has been tested and found to comply with limits for a Class B digital device, pursuant to Part 15 of the FCC rules. These limits are designed to provide reasonable protection against harmful interference in residential installations. This equipment generates, uses, and can radiate radio frequency energy, and if not installed and used in accordance with the instructions, may cause harmful interference to radio communications.

However, there is no guarantee that interference will not occur in a particular installation. If this equipment does cause interference to radio or television equipment reception, which can be determined by turning the equipment off and on, the user is encouraged to try to correct the interference by one or more of the following measures:

- Reorient or relocate the receiving antenna.
- Move the equipment away from the receiver.
- Plug the equipment into an outlet on a circuit different from that to which the receiver is connected.
- Consult the dealer or an experienced radio/television technician for additional suggestions.

You are cautioned that any change or modifications to the equipment not expressly approved by the party responsible for compliance could void your authority to operate such equipment.

The symbol of the crossed out wheeled bin indicates this product should not be placed in municipal waste. Instead, you need to dispose of the waste equipment by handing it over to a designated collection point for the recycling of waste electrical and electronic equipment.



Caution

1. Do not drop, puncture or disassemble the device; otherwise the warranty will be voided.
2. Avoid all contact with water, and dry hands before using.
3. Use the device with care.
Avoid pressing hard on the device body.
4. Use only the accessories supplied by the manufacturer.
5. Keep the device out of the reach of infants.
6. For your own safety, don't operate the device while driving.
This device is intended to be used as a car cam aid only.

- ❗ If car lighter still on after car power off, make sure to pull off the car charger, in case to run out all the battery or cause any accident.
- ❗ Over high/low temperature, will auto power off.

Product Overview

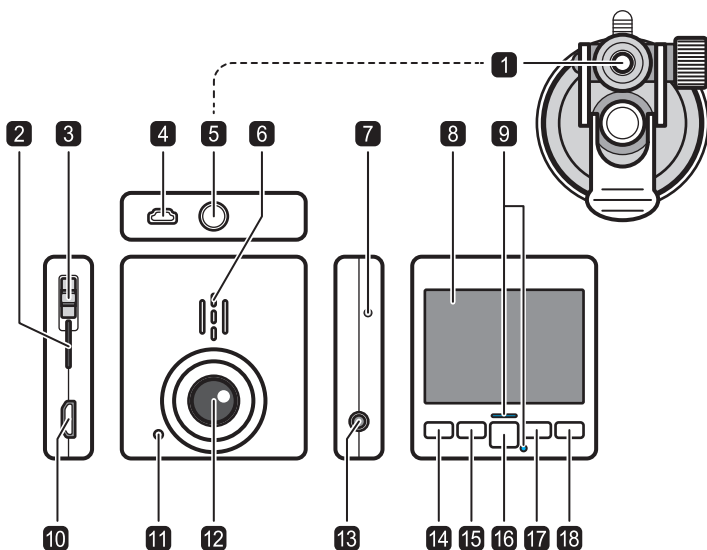

- | | |
|---|----------------------|
| 1 Removable Bracket | 10 HDMI out port |
| 2 MicroSD card slot | 11 Microphone |
| 3 Power Switch (On / off) | 12 Lens |
| 4 Power connector / USB port | 13 AV-out port |
| 5 Tripod socket | 14 Menu / Mode |
| 6 Speaker | 15 Playback / Return |
| 7 Reset button | 16 Lock file / OK |
| 8 LCD Display | 17 Up |
| 9 Led indicator (Led position may vary depending on the model.) | 18 Down / LCD off |

Install/Uninstall

● Installation

1. Attach the device to the bracket. Screw the bracket into the device tripod socket. Ensure that it is screwed in tightly.
2. Place the device in an appropriate place on the windshield, so as not to obstruct the driver's view.
3. Attach the bracket to the windshield. Push down on the suction cup of the bracket and use the side pump to pump out any excess air ensuring a tight seal.
4. Adjust the angle.
5. Connect to the car charger.

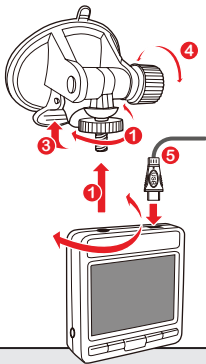
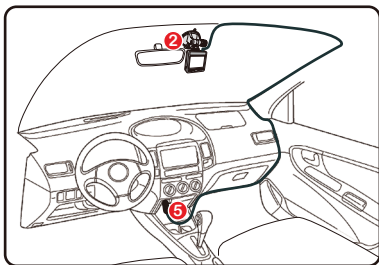

⚠ Air Safety Bag Warning

Do not put the device within the area of air safety bag. Our company is not responsible for any damage or injure caused by air safety bag.

- ⚠ Put the device around the area of front rear view mirror, to have better view.
- ⚠ Make sure the lens is within windshield wiper area, to have the clear video quality in the raining day.
- ⚠ Make sure the mount place is clean without dust.

● Uninstallation

1. To remove the bracket simply pull up the side bump.
2. Peel the suction cup off at one of the sides.

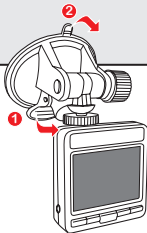

Start to Use

● Power On

1. Insert the car charger into the car lighter.
2. Connect the USB terminal to the device's USB port.
3. Insert MicroSD card into the MicroSD card slot, and switch for Power ON.

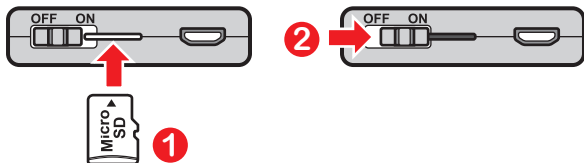

- ❗ Please use at least Class 6, 8GB MicroSD card.
- ❗ Before use, please formatting the MicroSD card.

● Recording

After start up the car engine, the device will auto power on and start cycled recording.

► Recording Icons

- | | |
|------------------------|----------------|
| ❶ Recording Icon | ❷ Video Time |
| ❸ Video Reserved Space | ❹ Current Time |
| ❺ Voice Recording | ❻ Menu |
| ❼ Playback | ❽ Lock file |
| ❾ LCD Off | |



● Playback

1. Press the Playback key (▶) to enter playback mode.
2. Select file types you want by Up(▲) or down key(▼).
3. Press OK key to show the video clip.
4. Use Up(▲) or down(▼) key to shift between files.
5. Press (▶) key to start playing.

▶ Playback Icons

- | | |
|------------------------------|-----------------|
| 1 Back to Recording Mode | 2 OK |
| 3 Up | 4 Down |
| 5 Play / Pause Key Icon | 6 Video Time |
| 7 Current / Total Recordings | 8 File name |
| 9 File Lock Icon | 10 Menu |
| 11 Back | 12 Play / Pause |
| 13 Next | 14 Previous |

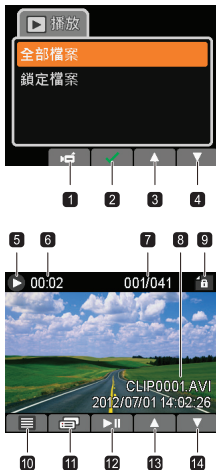

● Lock files in video reserved space

Two ways to save the current video clip as a read-only file to prevent for overwritten and delete.

1. Manual Lock :

Press Lock File button during recording to lock the current file.

2. Bump Auto Lock :

When any bump happened, will activate auto lock system.

- A “Beep“ sound will occur when any bump happened.
- A message “Lock File” will show on the screen.

① System can only save up to 5 locked files.

① A message, “ Reserved space is full” will show on the screen when 5 locked files exist. It's still recording while the message is showing..

① To free the reserved space, please enter Playback mode to change the file attribute from locked files to normal files.

● Realizing the LED indicator

LED color	Status
Red	Recording
Green	Standby
Glittering	Error / Warning

● Storage capacity

	1080P/30	720P/60	720P/30
8G	80 mins	120 mins	155 mins
16G	160 mins	240 mins	310 mins
32G	320 mins	480 mins	620 mins

Note : The actual value of capacity may vary (up to $\pm 30\%$) depending on the color saturation and complexity of your subject and surroundings.

Advanced Operations

● Menu Options in Setting mode

Item	Options	Description
Cycle Time	1min / 5 min	Each recording file is 1min / 5 min, and will overwritten while out of SD card memory.
Video Resolution	1080P 30fps / 720P 60fps / 720P 30fps	
Voice Recording	On / Off	On / off voice recording.
Bump Auto Lock (Sensativity)	Off / Low / Mid / High	To set the sensitivity level.
LCD Auto off	1min / 5 min / Always On	To set LCD always on or auto off after 1 or 5 minutes. *For safety driving, "Always On" is valid for one time only. The setting will be changed to "1 mins" when restarting.

Item	Options	Description
EV	-2 ~ +2	Manually adjust the exposure to gain better effect when the preview image appears too bright or too dark.
Beep	On / Off	Enable beep sound on/off.
Volume	Off / 1 / 2 / 3	Adjust system volume.
Date Stamp	On / Off	Enable time and date embedded on/off.
Clock		Set date and time.
Language		Support multi-languages.
TV System	NTSC / PAL	Set TV system compatibility to NTSC / PAL.
Flicker	50HZ / 60HZ	Set flicker frequency to 50HZ or 60HZ.
Format Card	Yes / No	Format the SD card. Note that all files will be gone.
Default	Yes / No	To have all settings reset to default status.

● Menu Options in Playback mode

Item	Options	Description
Slideshow	On / Off	Repeat playing all video files.
File attribute	Normal File / Locked File	Change the file attribute to normal file or locked file.

! Format function can delete all locked and unlock files.

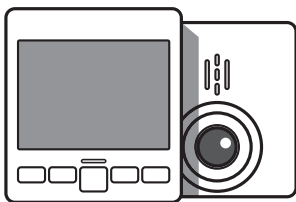

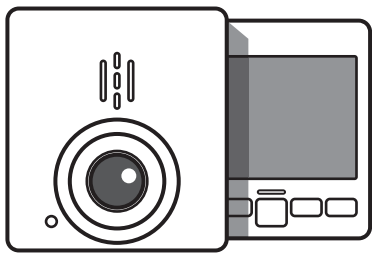

行車紀錄器

• 歡迎:

非常榮幸您選擇我們產品。
在使用之前，請詳細閱讀下面的聲明。

• FCC Compliance Statement:

This device complies with Part 15 of the FCC Rules. Operation is subjected to the following two conditions: (1) this device may not cause harmful interference, and (2) this device must accept any interference received, including interference that may cause undesired operation.

This equipment has been tested and found to comply with limits for a Class B digital device, pursuant to Part 15 of the FCC rules. These limits are designed to provide reasonable protection against harmful interference in residential installations. This equipment generates, uses, and can radiate radio frequency energy, and if not installed and used in accordance with the instructions, may cause harmful interference to radio communications.

However, there is no guarantee that interference will not occur in a particular installation. If this equipment does cause interference to radio or television equipment reception, which can be determined by turning the equipment off and on, the user is encouraged to try to correct the interference by one or more of the following measures:

- Reorient or relocate the receiving antenna.
- Move the equipment away from the receiver.
- Plug the equipment into an outlet on a circuit different from that to which the receiver is connected.
- Consult the dealer or an experienced radio/television technician for additional suggestions.

You are cautioned that any change or modifications to the equipment not expressly approved by the party responsible for compliance could void your authority to operate such equipment.

當本設備超過使用時效而必須予以丟棄時，請遵循法令進行所有配件的回收。

請勿將電池和充電電池和家用垃圾一同丟棄！請將電池和充電電池攜至當地的回收站進行回收。

讓我們為環境共盡一份心力。



注意事項

1. 本產品為精密儀器，請勿摔砸、碰撞或拆卸本產品，以免造成保固失效。
2. 務必遠離水源，並於使用時盡量保持雙手乾燥。
3. 請小心使用本產品，避免機身遭受強烈撞擊。
4. 請使用原廠提供之配件。
5. 請避免讓幼兒接觸本產品，以免發生誤食或觸電之危險。
6. 為了您自身安全，請勿在駕駛時操作產品的控制項目。本產品僅應作為行車記錄器使用。

- ❶ 當車輛熄火後點煙器仍供電的使用者，在離開車子時，務必將點煙器插頭拔起，以避免耗光電瓶內電力或造成其他意外狀況發生。
- ❷ 溫度過高/低，將進行關機。

產品概述

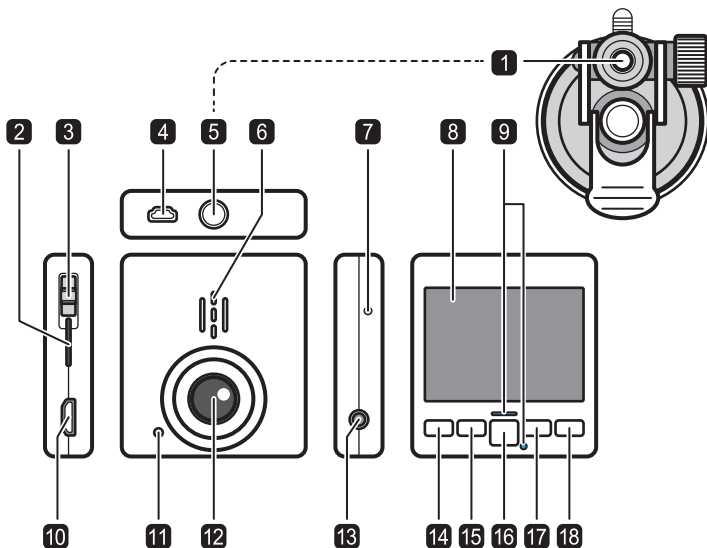

- ❶ 可拆式車架
- ❷ MicroSD 記憶卡插槽
- ❸ 電源開關 (開/關)
- ❹ 電源連接器 / USB 接口
- ❺ 車架孔
- ❻ 喇叭
- ❼ 重置鍵
- ❽ 液晶螢幕
- ❾ 指示燈 (位置根據機種有所差異)
- ❿ HDMI輸出接口
- ⓫ 麥克風
- ⓬ 鏡頭
- ⓭ 影音輸出接口
- ⓮ 選單
- ⓯
- ⓰ 檔案鎖定 / OK
- ⓱ 上
- ⓲ 下 / 關閉螢幕

安裝/拆卸

● 安裝方式

1. 將支架下方螺絲旋入產品主體，並請確保兩者有旋緊固定。
2. 請將機器放置於不會阻礙駕駛視線的地方。
3. 將車架吸盤黏貼於擋風玻璃上，並按下吸盤上方之吸盤撥鍵以固定車架。
4. 調整角度。
5. 連接車充。

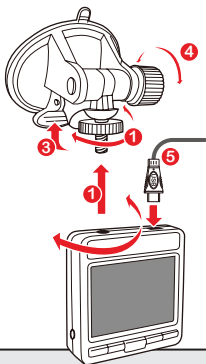
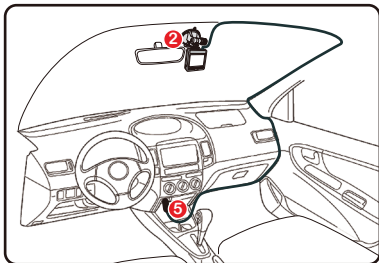

❗ 安全氣囊警告

切勿把機器安裝在安全氣囊彈蓋上或安全氣囊的工作範圍內。

本公司對因車輛碰撞或汽車安全氣囊的問題而導致的傷害或死亡不承擔任何責任。

❗ 盡可能安裝在靠近車內後視鏡附近，影像視野較佳處，不遮蔽觀看螢幕的位置。

❗ 鏡頭拍攝位置處於雨刷清潔範圍內，確保雨天可清晰拍攝。

❗ 請確保安裝的地方乾淨無灰塵。

● 主機拆卸

1. 要卸下車架，搬開吸盤撥鍵。
2. 從側邊撥開吸盤。



開始使用

● 開機

車用變壓器插入汽車點煙器插頭。

車用變壓器USB接頭插入主機USB孔。

MicroSD卡插入MicroSD插槽後，將電源開關右切至ON。

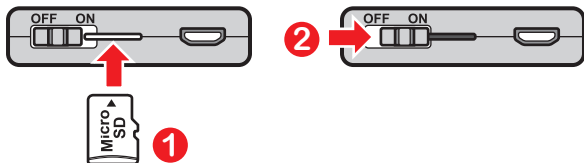

- ❗ 建議使用Class6、容量8GB以上之 MicroSD卡，本機最高支援 32GB。
- ❗ 使用前務必將 MicroSD卡進行格式化。

● 錄影

發動引擎後，將會自動開機並開始循環錄影。

<<錄影圖示>>

- | | |
|----------|--------|
| ❶ 錄影圖示 | ❷ 影片時間 |
| ❸ 檔案保留空間 | ❹ 目前時間 |
| ❺ 錄音 | ❻ 選單 |
| ❼ 播放 | ❼ 檔案鎖定 |
| ❽ 關閉螢幕 | |



● 播放

1. 按下播放鍵 (▶)進入播放模式。
2. 以上下鍵(▲ ▼)選擇你想要的檔案類別。
3. 按OK鍵出現錄影檔案。
4. 以上下鍵(▲ ▼)選擇你想要的檔案。
5. 按OK鍵開始播放。

<<播放圖示>>

- | | |
|----------------|------------|
| 1 返回錄影模式 | 2 OK |
| 3 上 | 4 下 |
| 5 播放 / 暫停圖示 | 6 影片時間 |
| 7 目前錄影 / 所有錄影數 | 8 檔案名稱 |
| 9 檔案鎖定圖示 | 10 選單 |
| 11 返回 | 12 播放 / 暫停 |
| 13 下一段 | 14 前一段 |

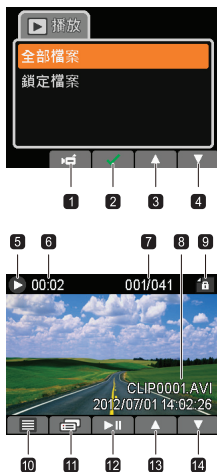

● 保留空間內的鎖定檔案

以下兩種方法可將影片儲存為鎖定的唯讀檔。

1. 手動鎖定：

在錄影狀態下，按下機台上的檔案鎖定鍵，正在錄製的檔案便會存成唯讀檔並保存在保留空間內。

2. 自動鎖定：

當有撞擊發生，裝置會啟動鎖定檔案機制 (G-sensor)。

- 當有撞擊發生，裝置會發出“噦”警告聲。
- 螢幕上會出現“鎖定檔案”警示語。

① 保留空間內容量可儲存 5 個鎖定檔案。

② 在保留空間內已有5個鎖定檔案，螢幕會出現“保留空間已滿”的警示語，此時本機仍保持錄影狀態。

③ 如需加入鎖定檔案，請由原先5個鎖定檔案變更檔案屬性為一般檔案，得以再加入新的鎖定檔案。

● 了解 LED 指示燈

LED 指示燈顏色	狀態
紅	錄影中
綠	待機
閃爍	錯誤 / 警告

● 存儲容量

	1080P/30	720P/60	720P/30
8G	80分鐘	120分鐘	155分鐘
16G	160分鐘	240分鐘	310分鐘
32G	320分鐘	480分鐘	620分鐘

註：實際儲存容量可能會因顏色飽和及場景複雜程度有高達30%的差異。

進階操作

● 設定選單項目

項目	選項	說明
循環時間	1分鐘 / 5分鐘	循環時間預設每段影片長度為1分鐘 / 5分鐘，並於SD卡空間不足時覆蓋舊檔。
攝影解析度	1080P 30fps / 720P 60fps / 720P 30fps	
錄音	開啟 / 關閉	開啟 / 關閉 錄音。
碰撞自動鎖定 (敏感度)	關閉 / 低 / 中 / 高	敏感度設定。
螢幕自動關閉	1分鐘 / 5分鐘 / 永遠開啟	設定螢幕永遠開啟或1、5分鐘後自動關閉。 *為了行車安全，“恆亮”設定只有一次性有效，當機台重新啟動後，設定值會回復為“5分鐘”。

項目	選項	說明
曝光補償	-2~ +2	當預覽畫面顯示太亮或太暗時，手動調整曝光補償，以獲得較佳的效果。
按鍵音	開啟 / 關閉	開啟或關閉按鍵音。
音量	關閉 / 1 / 2 / 3	調整系統音量大小。
日期顯示	開啟 / 關閉	啟用此功能會在影片中嵌入時間與日期。
時間設定	-	設定日期與時間。
語言	-	支援多國語系。
電視系統	NTSC / PAL	將電視系統相容性設為 NTSC / PAL。
閃爍頻率	50赫茲 / 60赫茲	設定閃爍頻率為 50赫茲或60赫茲。
格式化	是 / 否	格式化儲存媒體。 請注意：所有在儲存媒體上的檔案都會消失。
回復出廠設定	是 / 否	回復出廠預設值。請注意：所有目前設定都會被覆蓋。

● 回放模式下的選單

項目	選項	說明
循環播放	開啟 / 關閉	重複播放所有影片。
檔案屬性	鎖定檔案 / 一般檔案	變更檔案的屬性由鎖定檔案變更為一般檔案，亦可將一般檔案變更為鎖定檔案。

❗ 格式化功能可以刪除所有鎖定及非鎖定的檔案。

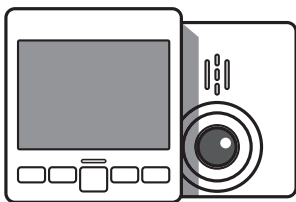

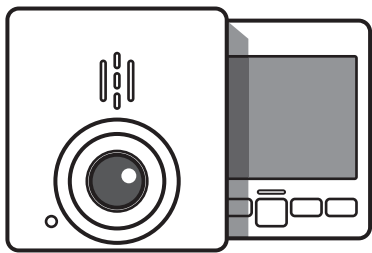

行车记录器

• 欢迎:

非常荣幸您选择我们的产品。

在使用之前，请仔细阅读下面的声明。

• **FCC Compliance Statement:**

This device complies with Part 15 of the FCC Rules. Operation is subjected to the following two conditions: (1) this device may not cause harmful interference, and (2) this device must accept any interference received, including interference that may cause undesired operation.

This equipment has been tested and found to comply with limits for a Class B digital device, pursuant to Part 15 of the FCC rules. These limits are designed to provide reasonable protection against harmful interference in residential installations. This equipment generates, uses, and can radiate radio frequency energy, and if not installed and used in accordance with the instructions, may cause harmful interference to radio communications.

However, there is no guarantee that interference will not occur in a particular installation. If this equipment does cause interference to radio or television equipment reception, which can be determined by turning the equipment off and on, the user is encouraged to try to correct the interference by one or more of the following measures:

- Reorient or relocate the receiving antenna.
- Move the equipment away from the receiver.
- Plug the equipment into an outlet on a circuit different from that to which the receiver is connected.
- Consult the dealer or an experienced radio/television technician for additional suggestions.

You are cautioned that any change or modifications to the equipment not expressly approved by the party responsible for compliance could void your authority to operate such equipment.



当本设备超过使用时效而必须予以丢弃时，请遵循法令进行所有配件的回收。

请勿将电池和充电电池和家用垃圾一同丢弃！请将电池和充电电池携至当地的回收站进行回收。

让我们为环境共尽一份心力。



注意事項

1. 本产品为精密仪器，请勿摔砸、碰撞或拆卸本产品，以免造成保固失效。
2. 务必远离水源，并于使用时尽量保持双手干燥。
3. 请小心使用本产品，避免机身遭受强烈撞击。
4. 请使用原厂提供之配件。
5. 请避免让幼儿接触本产品，以免发生误食或触电之危险。
6. 为了您自身安全，请勿在驾驶时操作产品的控件目。本产品仅应作为行车纪录器使用。

❶ 当车辆熄火后点烟器仍供电的使用者，在离开车子时务必将点烟器插头拔起，以避免耗光电瓶内电力或造成其余意外状况发生。

❶ 温度过高/低，将进行关机。

产品概述

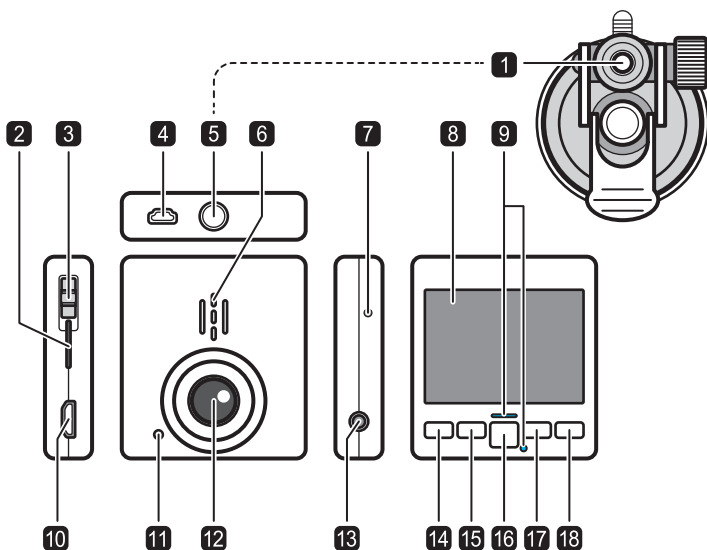

- 1 可拆式车架
- 2 MicroSD 记忆卡插槽
- 3 电源开关 (开/关)
- 4 电源连接器 / USB 埠
- 5 车架孔
- 6 喇叭
- 7 重置键
- 8 液晶屏幕
- 9 指示灯 (位置根据机种有所差异)
- 10 HDMI输出埠
- 11 麦克风
- 12 镜头
- 13 影音输出埠
- 14 选单
- 15 回放 / 返回
- 16 档案锁定 / OK
- 17 上
- 18 下 / 关闭屏幕

安装/拆卸

● 安装方式

1. 将支架下方螺丝旋入产品主体，请确保两者旋紧固定。
2. 请确保将机器放置于不会阻碍驾驶视线的地方。
3. 将车架吸盘黏贴上挡风玻璃，按下吸盘上方之吸盘拨键以固定车架。
4. 调整角度。
5. 连接车充。

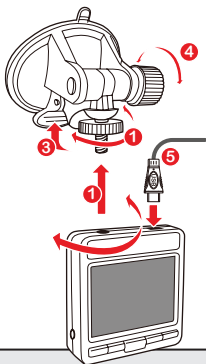
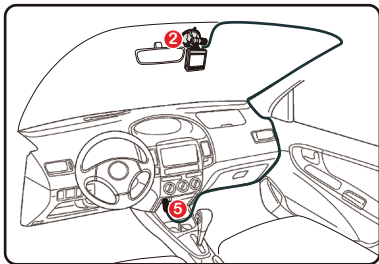

⚠ 安全气囊警告

切勿把机器安装在安全气囊弹盖上或安全气囊的工作范围内。

本公司对因车辆碰撞或汽车安全气囊的问题而导致的伤害或死亡不承担任何责任。

- ⚠ 尽可能安装在靠近车内后视镜附近，影像视野较佳处，不遮蔽观看荧幕的位置。
- ⚠ 镜头拍摄位置处于雨刷清洁范围内，确保雨天可清晰拍摄。
- ⚠ 请确保安装的地方干净无灰尘。

● 主机拆卸

1. 要卸下车架，搬开吸盘拨键。
2. 从侧边拨开吸盘。

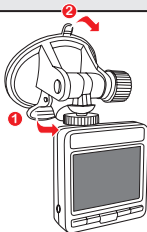

开始使用

● 开机

车用变压器插入汽车点烟器插头。

车用变压器USB接头插入主机USB孔。

MicroSD卡插入MicroSD插槽后，将电源开关右切至ON。

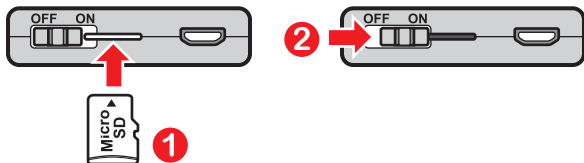

- ❗ 建议使用Class6、容量8GB以上之 MicroSD卡，本机最高支援 32GB。
- ❗ 使用前务必将 MicroSD卡进行格式化。

● 录影

发动引擎后，将会自动开机并开始循环录影。

<<录影图示>>

- | | |
|----------|--------|
| ❶ 录影图示 | ❷ 影片时间 |
| ❸ 影片保留空间 | ❹ 目前时间 |
| ❺ 录音 | ❻ 选单 |
| ❼ 回放 | ❸ 档案锁定 |
| ❾ 关闭屏幕 | |



● 回放

1. 按下回放键 (▶)进入拨放模式。
2. 以上下键(▲ ▼)选择你想要的档案类别。
3. 按OK键出现录影档案。
4. 以上下键(▲ ▼)选择你想要的档案。
5. 按OK键开始回放。

<<回放图示>>

- | | |
|----------------|------------|
| 1 返回录影模式 | 2 OK |
| 3 上 | 4 下 |
| 5 回放 / 暂停图示 | 6 影片时间 |
| 7 目前录影 / 所有录影数 | 8 档案名称 |
| 9 档案锁定图示 | 10 选单 |
| 11 返回 | 12 回放 / 暂停 |
| 13 下一段 | 14 前一段 |

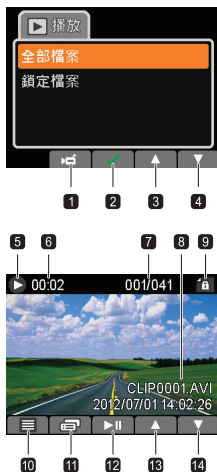

● 保留空间内的锁定档案

以下两种方法可将影片储存为锁定的唯读档。

1. 手动锁定：

在录影状态下，按下机台上的档案锁定键，正在录制的档案便会存成唯读档并保存在保留空间内

2. 自动锁定：

当有撞击发生，装置会启动锁定档案机制(G-sensor)。

- 当有撞击发生，装置会发出“哔”警告声
- 荧幕上会出现“锁定档案”警示语

❗ 保留空间内容量可储存 5 个锁定档案。

❗ 在保留空间内已有5个锁定档案，荧幕会出现“保留空间已满”的警示语，此时本机仍保持录影状态。

❗ 如需加入锁定档案，请由原先5个锁定档案变更档案属性为一般档案，得以再加入新的锁定档案。

● 了解 LED 指示燈

LED 指示灯颜色	状态
红	录影中
绿	待机
闪烁	错误 / 警告

● 存儲容量

	1080P/30	720P/60	720P/30
8G	80分钟	120分钟	155分钟
16G	160分钟	240分钟	310分钟
32G	320分钟	480分钟	620分钟

注：实际储存容量可能会因颜色饱和及场景复杂程度有高达30%的差异。

进阶操作

● 設定選單項目

項目	選項	說明
循环时间	1分钟 / 5分钟	循环时间预设每段影片长度为1分钟 / 5分钟，并于SD卡空间不足时覆盖旧档。
摄影解析度	1080P 30fps / 720P 60fps / 720P 30fps	
录音	开启 / 关闭	开启 / 关闭 录音。
碰撞自动锁定 (敏感度)	关闭 / 低 / 中 / 高	敏感度设定。
荧幕逾时	1分钟 / 5分钟 / 永远开启	设定荧幕永远开启或1、5分钟后自动关闭。 *为了行车安全，“恒亮”设定只有一次性有效，当机台重新启动后，设定值会回复为“5分钟”。

项目	选项	说明
曝光补偿	-2~ +2	当预览画面显示太亮或太暗时，手动调整曝光补偿，以获得较佳的效果。
按键音	开启 / 关闭	开启或关闭按键音。
音量	关闭 / 1 / 2 / 3	调整系统音量大小。
日期打印	开启 / 关闭	启用此功能会在影片中嵌入时间与日期。
时间	-	设定日期与时间。
语言	-	支援多国语系
电视系统	NTSC / PAL	将电视系统相容性设为 NTSC / PAL
交流频率	50HZ / 60HZ	设定闪烁频率为 50Hz或60Hz。
格式化	是 / 否	“格式化储存媒体。 请注意：所有在储存媒体上的档案都会消失。”
回复出厂设定	是 / 否	回复出厂预设值。请注意：所有目前设定都会被覆盖。

● 回放模式下的选单

项目	选项	说明
循环播放	开启 / 关闭	重复播放所有影片。
档案属性	锁定档案 / 一般档案	变更档案的属性由锁定档案变更为一般档案，亦可将一般档案变更为锁定档案。

❗ 格式化功能可以删除锁有锁定及非锁定的档案。

