



胶装说明书

单页尺寸: 100mmX130mm

封面: 157G双铜纸过哑胶

内页: 100G双胶纸



橙色以
1655C为准

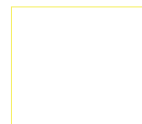

轮廓线
不需印刷

Hey, find us here:



VANTRUE www.vantrue.net/contact



 facebook.com/vantrue.live

Always a surprise in Vantrue

CONTENTS

VERZEICHNIS

日本語作業マニュアル

1. What's in the box?	3
Was ist in der Box?	31
付属品を確認する	62
2. Camera Overview	4
Die Übersicht über Kamera	32
各部の名称とはたらき	63
3. Getting Started	6
Vorbereitung vor dem Einschalten	35
入門	65
4. Basic Operation	10
Grundlegende Operation	39
基本的な使い方	69
5. Specifications	28
Spezifikationen	58
製品仕様	86
6. Warranty & Support	29
Garantie und Unterstützung	60
保証とサポート	87

1. What's in the box?



A. Car Charger with Built-in Type-C Cable (11.4 ft)

C. Suction Cup Mount

E. User Manual

G. Warranty Card

I. Rear Camera Cable (20 ft)

B. VANTRUE® N4 Dash Cam

D. Type-C USB Data Cable (3ft)

F. Quick Start Guide

H. Rear Camera(0.98 ft)

J. Adhesive Sticker

2. Camera Overview

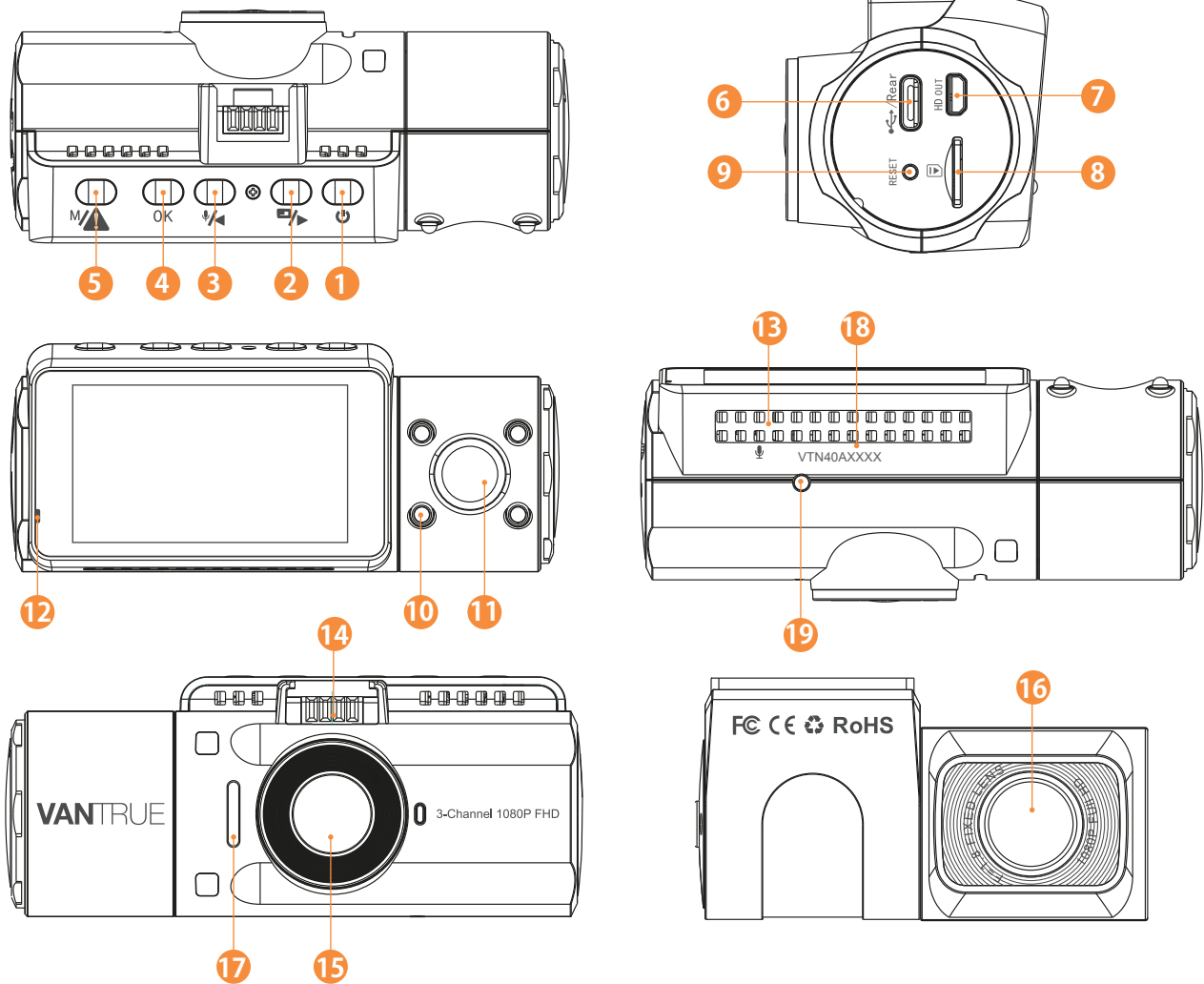

NO.	Name	Description
1	Button	Power ON/OFF; IR LED Light Switch.
2	Button	Move selector down; Switch the Front, cabin and rear camera window display ; Fast forward when playing back videos.
3	Button	Move selector up; Microphone on/off; Slow forward when playing back videos.
4	Button	Confirms the action; Stop/Start the video recording.

5	 Button	Enter/exit setup menu; Long press to enter Parking Mode; Manually locks the currently recording video clip following emergency or to preserve important videos.
6	Type-C USB / Rear Cam Port	Type-C USB port for charging or transferring data; Video stream port for streaming rear camera's recording.
7	Micro HD Out Port	For HDMI cable connecting to HDTV.
8	MicroSD Card Slot	Provides expandable storage (up to 256GB in FAT32, U3 or higher).
9	Reset Button	Press to force reset the device.
10	IR LED Light	4 IR LED lights enhances the night vision in car.
11	Cabin Camera	Camera for in-car video recording.
12	Indicator light	Blue light blinking when recording; Light on when charging.
13	Microphone	Records clear audio with the video footage.
14	Mount Connector	Connects to the Suction Cup Mount.
15	Front Camera	Front Facing Camera for video recording road events.
16	External Camera	External Camera for video recording rear road events.
17	Speaker	Delivers sound during video playback.
18	Serial Number	Serial Number for Warranty Registration.
19	IR Light Sensor	Sense the light changing.

LED Indicator

Blue light is visible on the Indicator light [12]

Camera is charging.

Blue light blinks on the Indicator light [12]

Camera is recording.

Screen overview

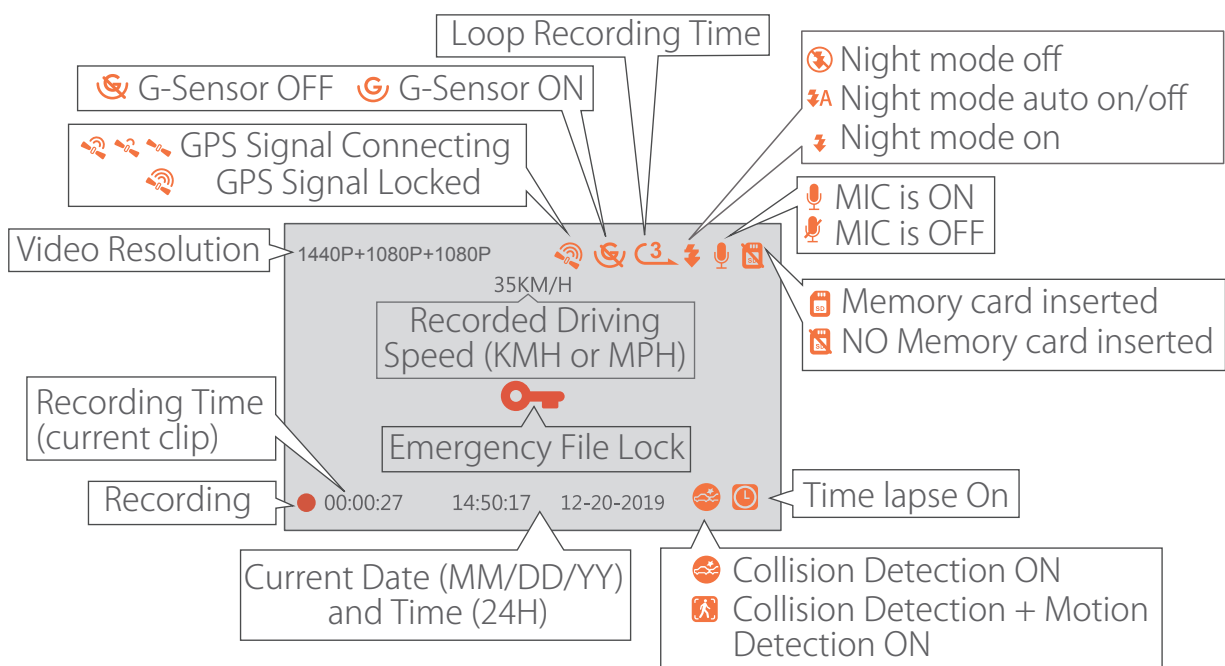

3. Getting Started

3.1 Installing a Memory Card (Recommend VANTRUE microSD Card)

Please use a genuine Micro SD memory card from 32GB to 256GB with a speed rating of U3 or higher. We recommend use Vantrue Micro SD Card (not include). Please insert the SD card when dash cam is off. Carefully insert the memory card into the camera's card slot until it clicks. To remove the card, power off the camera first, then push the card into the slot until it clicks again.

If you are using SD card from other brand, before using the card, press (OK) button to stop the recording.

- Press (M/!) button to enter setup; if the camera is recording video, press (OK) button to stop the recording; if it says 'SD card error, please format SD card' here, please press the (OK) button and press (M/!) button to access into the menu.
- Press the (E/▶) button to highlight the System Setup option, press the (OK) button to confirm.
- Press the (E/▶) button to highlight the Format option, press the (OK) button to confirm by the (E/▶) button to select format.

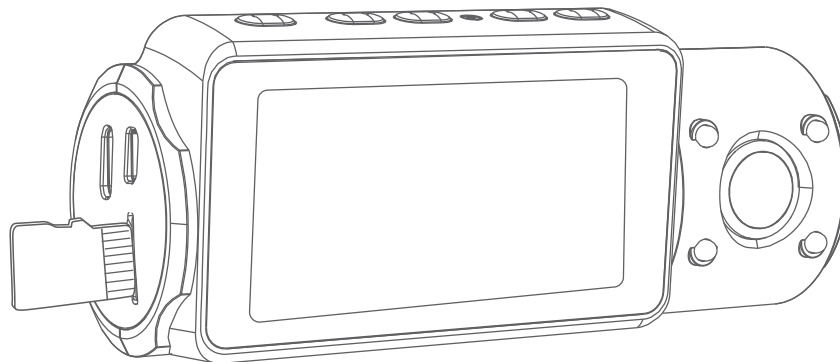

REMINDER:

1. The microSD card should be formatted once a month to maximize the lifetime of the memory card.
2. Please do not take the card out when the camera is recording in case that the important video files missing.
3. Please don't use Sandisk or Transcend SD card on this dash cam.

3.2 Installing the camera onto your windshield

1. Attach the Suction Mount to the camera's Mount Connector, pushing it in until it clicks.

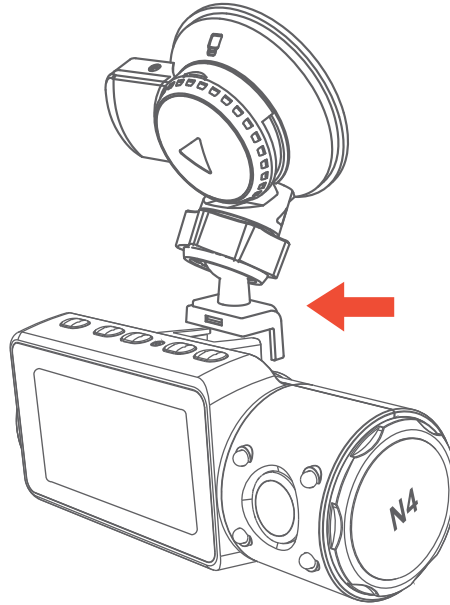

2. Thoroughly clean the windshield using water or alcohol, and wipe clean with a dry cloth.
3. Wipe the Suction Mounting Pad clean on the Suction Mount.
4. Securely attach the Suction Mount to the windshield, and rotate the locking clamp on the mount **90°** upward until it clicks.

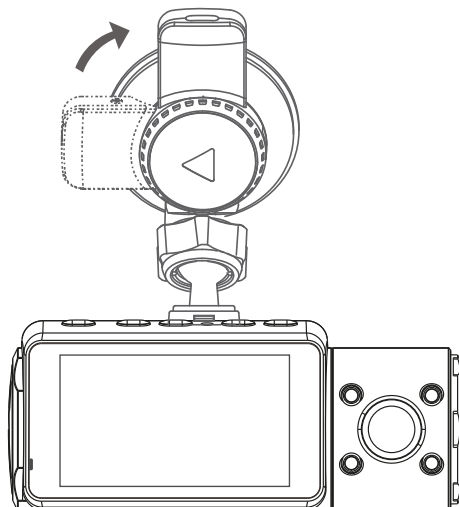

- Carefully route the power cable around the windscreen and tuck it under the trim.

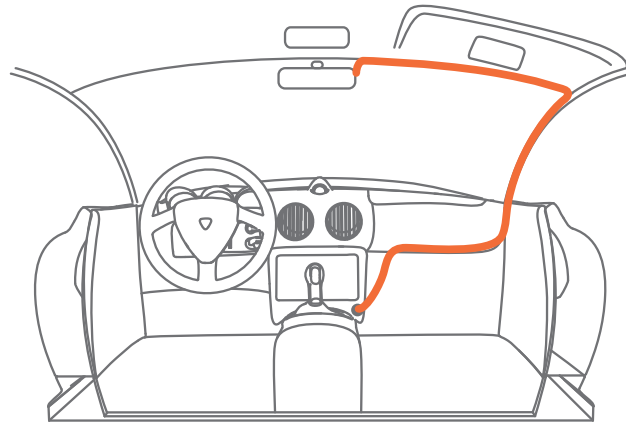

- Connect the External Camera to the Rear Cam Port on the device through the rear camera cable, carefully route the cable and tuck it under the trim.



- With the Type-C USB Cable, connect the supplied Car Charger to the Front Camera Mount Base.

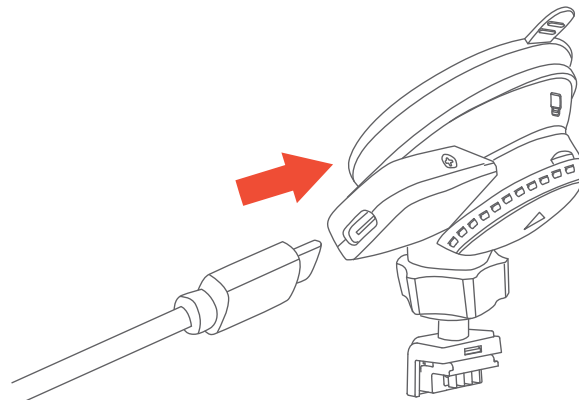

8. Insert the Car Charger into your vehicle's cigarette lighter port.

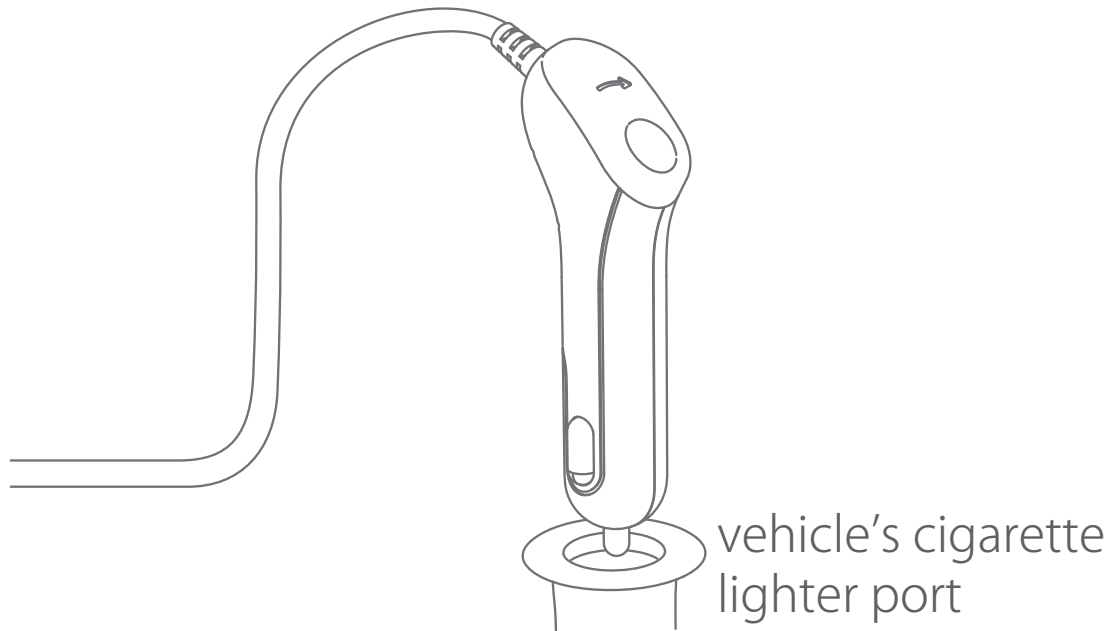

9. Start the car.
10. The camera will auto power on and start recording.

4. Basic Operation

4.1 Power ON/OFF

Once the car starts on, the camera will automatically turn on and start recording.

A. Manually

Long press the  button to power it OFF.

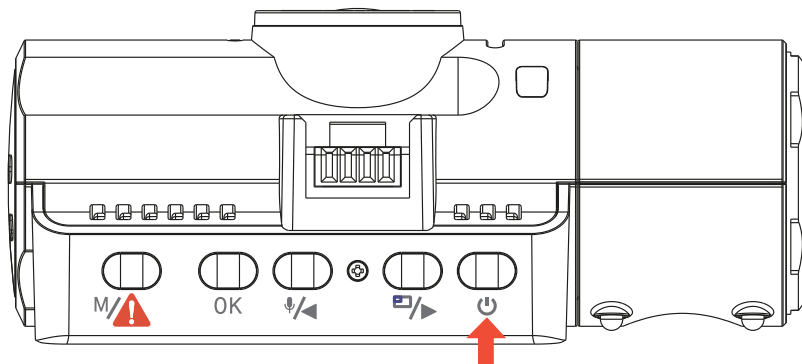

B. Automatically



The camera will power off if the charger cable is disconnected or if the vehicle is turned off.

Note:

1. The device has two USB ports available for power supply—on the camera or via the suction cup mount.
2. When charging via computer, please use the USB port located on the mount. If you use the USB port on the camera, “USB Connecting ” and “Power On” will be displayed on the camera screen, please select “Power on” to charge the dash cam.

4.2 Menu Settings

After powering ON the camera, press the  button to enter the setup process.

(If the camera is recording video, press the  button to stop recording before pressing the  button.)

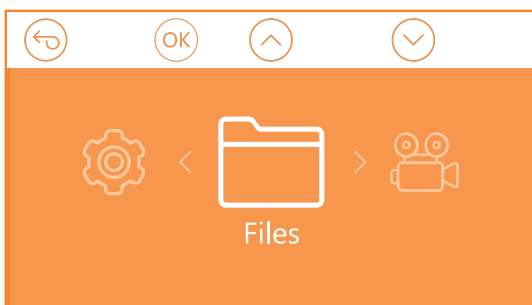
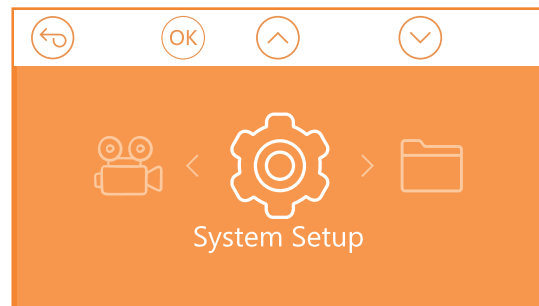
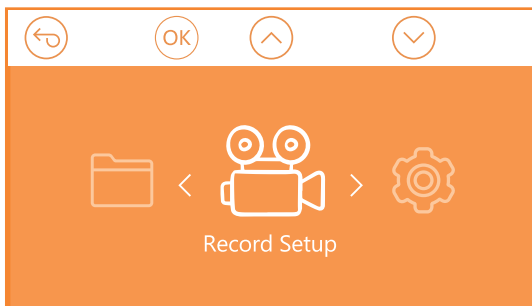

A. Record Setup

Press the **(OK)** button to enter the settings, and use the **(📷/◀)** or **(▶/📷)** buttons to navigate the different options.





- **Resolution:** Press the **(📷/◀)** or **(▶/📷)** button to toggle the recording mode and resolution.
Front+Cabin+Rear Mode: 1440P+1080P+1080P 30FPS;
1080P+1080P+1080P 30FPS; 1080P+1080P+720P 30FPS;
720P+720P+720P 30FPS;
Front+Cabin Mode: 1440P+1080P 30FPS; 1080P+1080P 30FPS;
1080P+720P 30FPS; 720P+1080P 30FPS; 720P+720P 30FPS;
Front+Rear Mode: 1440P+1080P 30FPS; 1080P+1080P 30FPS;
1080P+720P 30FPS; 720P+1080P 30FPS; 720P+720P 30FPS;
Single Front Cam Mode: 2592x1520P 30FPS; 2560x1440P
30FPS; 1920x1080P 30FPS; 1280x720P 30FPS.
- **Loop Recording:** Press **(OK)** button to change the duration:
1Min, 3Min, 5Min, and OFF.
- **IR IEDs:** Press the **(OK)** and **(📷/◀)** or **(▶/📷)** button to select the section: Auto, On and Off.
- **G-Sensor Set:** Pressing **(OK)** button gives the following sensitivity options: Low, Medium, High, Off.
- **Audio Recording:** Press **(OK)** button and **(▶/📷)** button to toggle it OFF/ON.
- **Parking Mode:** Press **(OK)** and **(▶/📷)** button to change the options: Collision Detection, Collision + Motion Detection, OFF.
- **Exposure:** Press **(OK)** and **(📷/◀)** or **(▶/📷)** button to select between Front, Cabin and Rear exposure.
Front:
+2.0, +5/3,+4/3,+1.0,+2/3,+1/3,+0.0,-1/3,-2/3,-1.0,-4/3,-5/3,-2.0
Cabin:
+2.0,+5/3,+4/3,+1.0,+2/3,+1/3,+0.0,-1/3,-2/3,-1.0,-4/3,-5/3,-2.0
Rear:

+2.0,+5/3,+4/3,+1.0,+2/3,+1/3,+0.0,-1/3,-2/3,-1.0,-4/3,-5/3,-2.0

- **WDR:** Press (OK) and (⏪/▶) button to toggle it OFF/ON.
- **Number Plate:** Press (⏪/▶) or (⏪/▶) and (OK) to set your car license number.
- **Stamp:** Press (OK) to toggle it OFF/ON. Stamp shows the date/time, logo, car number, Speed and GPS Location information.
- **Rotate Display:** Press (OK) and (⏪/▶) or (⏪/▶) button to select the options: Front+Cabin, Rear.
- **Time Lapse:** Press (OK) and (⏪/▶) button to toggle it OFF/ON.

B. System Setup

- **Language:** Press (OK) and (⏪/▶) or (⏪/▶) button to select between English, Simplified Chinese, Japanese, Deutsch, Italian, Spanish, French and Russian.
- **Format memory Card:** Press (OK) , navigate button and select format to format the micro SD card.
- **Time & Date:** Press (⏪/▶) or (⏪/▶) and (OK) button to set the current date and time. Press the (M/⚠) button to exit.
- **Auto LCD Off:** If the setup is 3 min, the dash cam screen would auto turn off after 3 min it start recording. If the setup is off, the screen will not turn off. Press the (⏪/▶) button to select the duration in minutes: 30sec, 1Min, 3Min or OFF to disable it.
- **Device Sound:** Press the (⏪/▶) or (⏪/▶) button to adjust the device sound.
- **Frequency:** Press (OK) button to toggle between 50Hz/60Hz.
- **System Info:** Press (OK) button to check the current firmware version and Website. (System Info)
- **Default Setting:** Press (OK) and (⏪/▶) Button to select (OK) to reset the device back to stock factory settings.
- **GPS:** Press the (OK) button to toggle it ON/OFF.

- **Speed Unit:** Press  or  and  button to select either KM/H or MP/H.
Press the  button to exit and complete the setup.



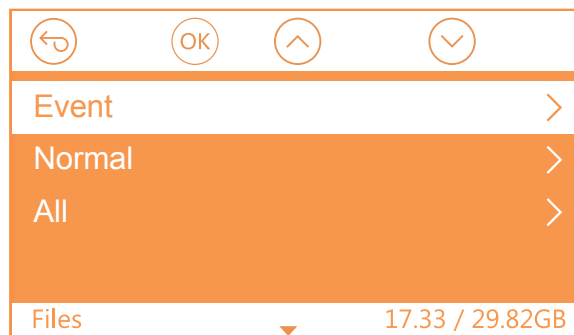

C. Files

Review and delete videos stored in the file folders.

- **Event:** Critical event videos detected by G-Sensor activity or manually locked by user.
- **Normal:** Standard videos recorded.
- **All:** All the standard videos and critical event videos recorded.



4.3 Set Date/Time

Open the MENU interface, navigate to “System Setup” > “Time & Date”, and press the  button to set the date/time. Navigate  or  to select date and time values. Press  button to confirm and proceed. To finish setup, just press the  button to exit.

Note: Date default format is MM/DD/YY with the time in 24 hour format.

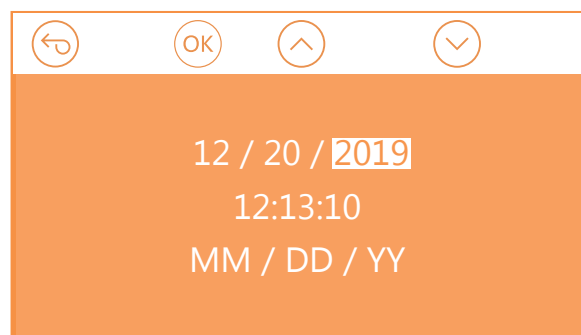



4.4 Switch Recording Mode/Resolution

By default (Front+ Cabin+ Rear RECORDING mode), 1440P+1080P+1080P resolution will show on the screen, the 3 cameras will simultaneously capture road front, inside cabin, and rear at 1440P+1080P+1080P (30fps).



It can be switched to Front+Cabin , Front+Rear or Front mode with following steps:

- Go to “Record Setup”>“Resolution”, Navigate  or  to select Recording Mode. Press  button to confirm and proceed.

Front+Cabin+Rear Mode: 1440P+1080P+1080P 30FPS;
1080P+1080P+1080P 30FPS; 1080P+1080P+720P 30FPS;
720P+720P+720P 30FPS;

Front+Cabin Mode: 1440P+1080P 30FPS; 1080P+1080P 30FPS; 1080P+720P 30FPS; 720P+1080P 30FPS; 720P+720P 30FPS;

Front+Rear Mode: 1440P+1080P 30FPS; 1080P+1080P 30FPS; 1080P+720P 30FPS; 720P+1080P 30FPS; 720P+720P 30FPS;

Front Mode: 2592x1520P 30FPS; 2560x1440P 30FPS; 1920x1080P 30FPS; 1280x720P 30FPS

To finish setup, just press the  button to exit.

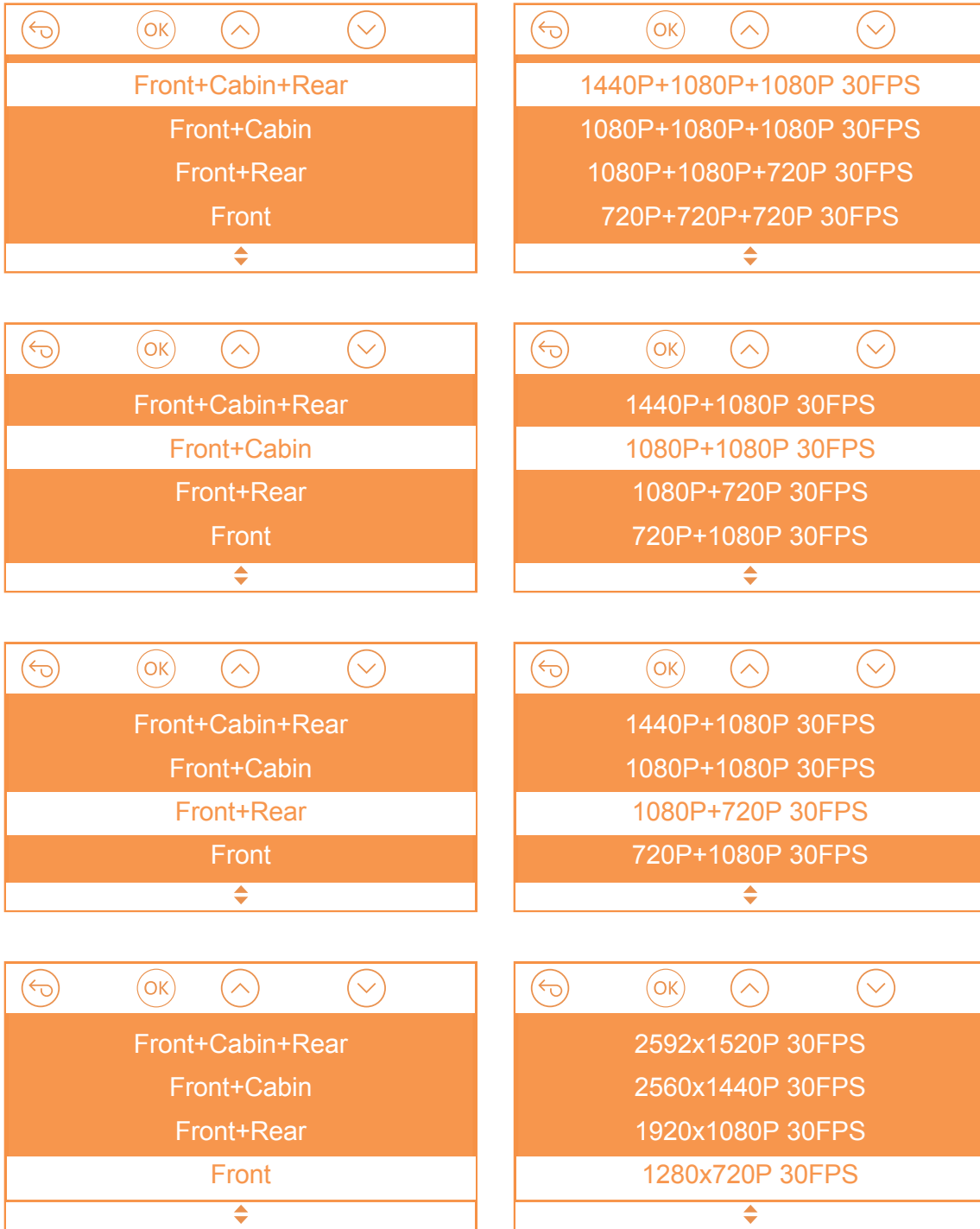

4.5 Switch the Front, cabin and rear camera window display

In three way or two-way recording mode, you can press the  button to switch display so the rear/inside camera shows bigger on the lcd.



Rear Camera Bigger



Inside Camera Bigger



Front Camera Bigger

4.6 Loop Recording

With a memory card inserted, the camera will (by default) immediately start loop recording video when connected to a power source and powered ON. If the device is not connected to a power source, it will not immediately start on and record. While recording, the Record indicator will blink and a red dot will flash on the lower corner left of the screen. You can stop/start the recording at any time by pressing the (OK) button.



By default, the Loop Recording Time is 3 minutes. Please go to “Record Setup” > “Loop Recording” to change it to 1 min, 3 mins, or 5 mins for your need.

The loop recording video file name format is “Year_Date_-Time_A.MP4”. For example: “2019_11_8_060101_A.MP4”. The suffix A indicates front cam recorded files, while the suffix B refers to cabin cam recorded files and the suffix C indicates the External cam recorded files. Standard files are stored in the “Video/Normal” folder. When the Micro SD card is full, the camera will write over older files.

When Loop Recording is turned off, the camera will record video in 20 minute clips, but will not overwrite old videos when the storage card is full.

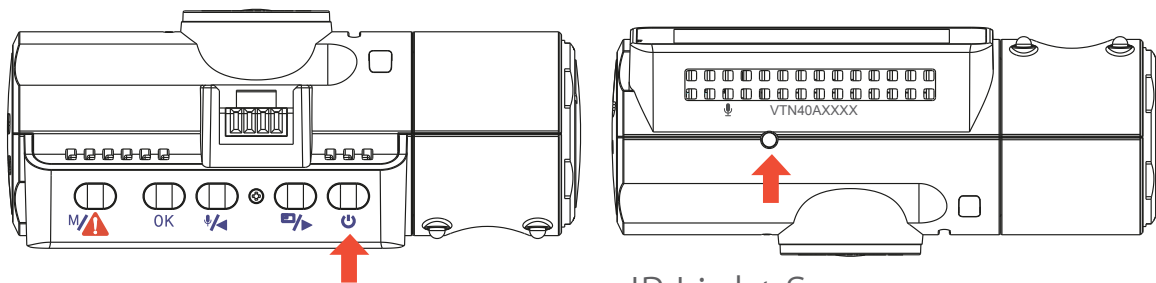

4.7 IR LED Light

By default, the IR LED light is auto on. Short Press  button to toggle the night vision mode ON, Auto ON/OFF, OFF.



IR Light Sensor



-  Night mode off
-  Night mode auto on/off
-  Night mode on

Please note: If IR lights on, the video footage of the cabin will turn into black and white.

4.8 Event Recording

Critical event detection is triggered by the G-Sensor (Gravity Sensor) and will auto-detect vehicle impacts and collisions. This will cause the camera to protect the current video clip from being overwritten by locking it and saving the footage in the “Video/Event” folder.

The user can also manually lock the current video recording session by pressing the  Button. A key icon will appear at the center of the screen.

The G-Sensor sensitivity is adjustable with 3 settings: Low, Medium, and High – it is set to Medium by default. The G-Sensor can also be deactivated in “Record Setup” > “G-Sensor”.

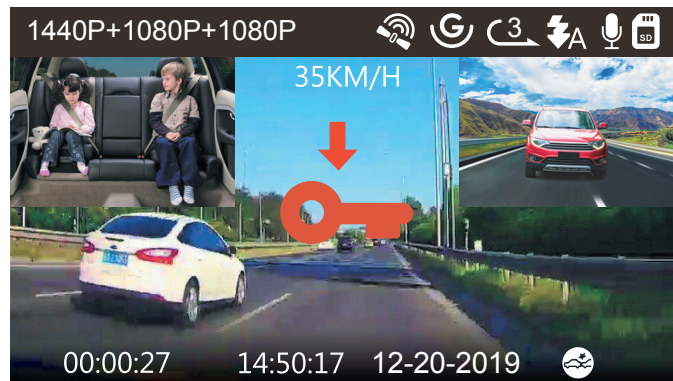

Event videos are stored in the “Video/Event” folder, and cannot be automatically overwritten.

Note: The camera will auto overwrite old Event videos once the Event folder has accumulated 25% of the card capacity. Please regularly transfer important videos to your PC or another storage location (e.g. external hard drive). To maintain good read/write performance, the microSD card should be formatted at least once a month.

4.9 Voice Recording

By default, the voice recording is ON. It can be turned OFF using either of the following methods:

- Go to “Record Setup” > “Audio Recording”, press (OK) button and select OFF;
- While recording video, press the (MIC) button to toggle voice recording OFF/ON.

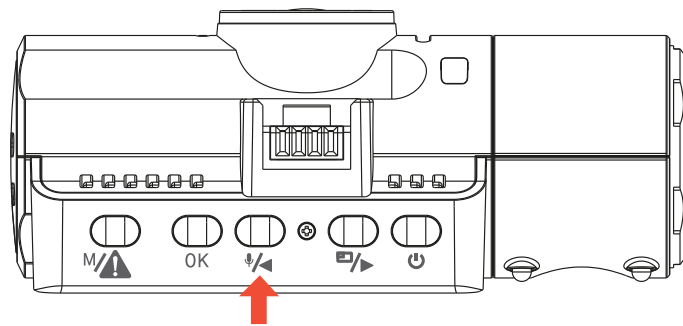

When the voice recording has been turned OFF, the MIC icon at the top of the screen will turn white with a red line across it.

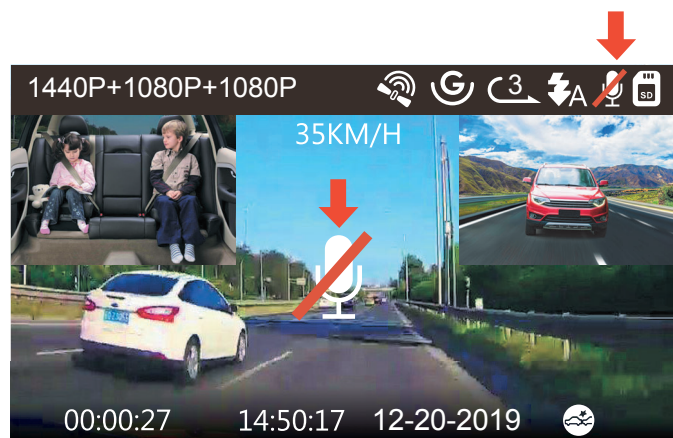

4.10 Parking Mode (Constant Power Supply Needed)

Parking Mode operates as a sentry function under different situations. To activate Parking Mode, go to “Record Setup” > “Parking Mode”, press (OK) and select the following options: Collision Detection, Collision Detection + Motion Detection, OFF.

4.10.1 Collision Detection Triggered

When the Collision Detection has been turned on, and no movement is detected after 5 minutes of recording, then Collision Detection is activated with a Collision Detection icon at the bottom right corner of the screen, and the camera automatically to turn off. Full frame recording will be triggered by the Collision Detection sensor. Once front camera detects vehicle impacts or collision, it will auto turn on and start auto recording; it will stop recording and auto off again after 5 minutes of inactivity.

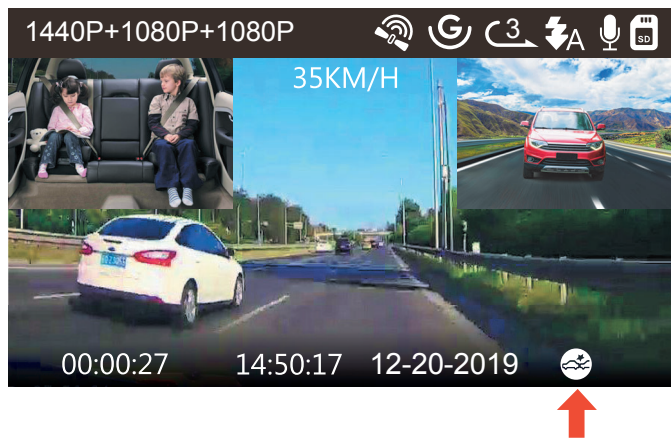

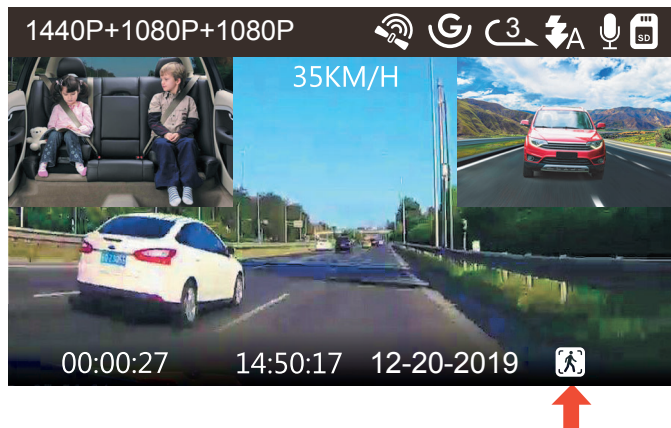

4.10.2 Collision Detection + Motion Detection Triggered

When the Collision Detection + Motion Detection has been turned on, this is represented by an Collision Detection + Motion Detection icon at the bottom right corner of the screen.

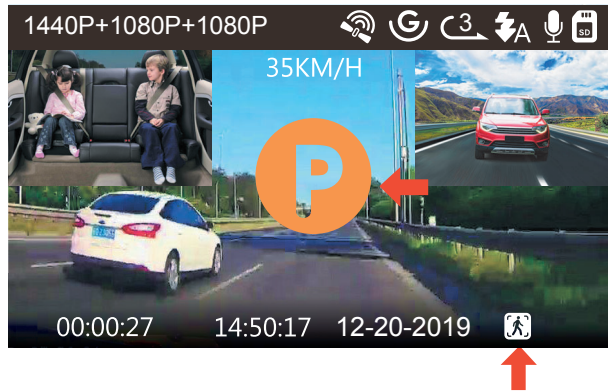

If no movement is detected after 5 minutes of recording, there will be an orange P icon appears in the center of the screen which means Parking Mode is activated. Once the camera detects movement in front, the front camera will start auto-re-recording; it will stop recording after 10 seconds of inactivity.



To manually activate Parking Mode, press and hold the  button until the P icon appears on the screen.

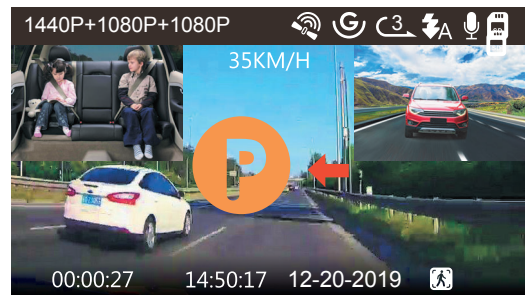
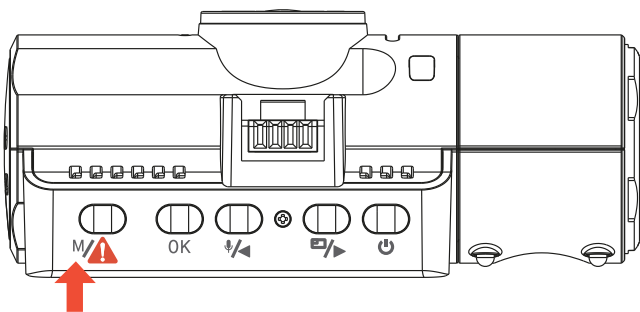

In Parking Mode, the camera will exit Parking Mode if it detects any vibration (Such as opening and closing the door, or moving the car from rest, or other impact vibrations can be triggered), and enter the Normal Video Mode.

In Parking Mode, if you set the Auto LCD OFF to 3 minutes, the camera's LCD will light off after 3 minutes but recording will continue with blue light blinks on the Indicator light .

NOTE: To ensure the camera is able to function in Parking Mode, please keep it powered with a mobile power bank or

hardwire it directly to the car battery. We do not recommend running the camera continuously for too long time.

4.11 TIME LAPSE

If TIME LAPSE is selected, the camera will take static photos at the set time interval at 1 second to create a video montage. If you set up the time lapse, the camera will take one photo every second, and then stitch the photos together into a 30 fps video. With a maximum recording frame rate of 30fps, recording 8 hours of video with Time Lapse 1Sec will generate a time lapse video lasting just 16 minutes (=8 x 60 x 60/30/60). This Eco Mode is recommended for storage cards with smaller capacities.

[Normal Recording Time = Time Lapse Recording Time (Sec) x Recording Frame Rate FPS x Time Lapse Option]

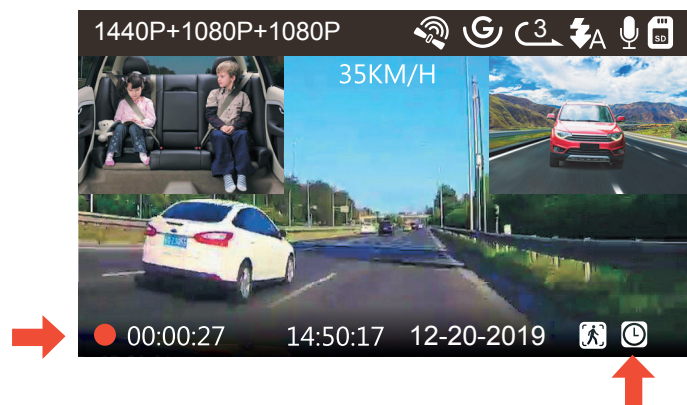

4.12 Connecting External GPS Receiver (Optional Accessory)

To use the camera's GPS function, please purchase an external GPS receiver mount. This can be purchased from Amazon.

1. Install the External GPS Mount onto the camera instead of the original mount.

2. Plug the Type C USB Connector into the GPS Mount to power it.
3. Once charged, the camera will power on. Recording will commence if a microSD card has been inserted, just press the (OK) Button to stop recording.
4. Press the (M/!) button to enter setup, go to "System Setup" > "GPS " to activate the camera's GPS function.
5. The GPS receiver will start to search for a GPS signal, the GPS icon will keep flashing on the screen. Once the GPS signal has been received and locked, the icon will stop flashing.



6. You can include GPS tracking and vehicle speed on the video footage, go to "Record Setup" > "Stamp" > "GPS Location Stamp" and "Speed Stamp" to set.
7. You can review recorded video using the VANTRUE® GPS Viewer (available for download on www.vantrue.net).

4.13 Viewing Video on the Camera

Press (M/!) button and go to "Files", press (OK) and (M/!) or (M/!) button to navigate to > "Normal" or > "Event" file folders to view and playback videos on the camera display. Use the (M/!) or (M/!) buttons to select the file and press (OK) button to playback/pause. During playing back, press (M/!) to slow forward and press (M/!) to fast forward.

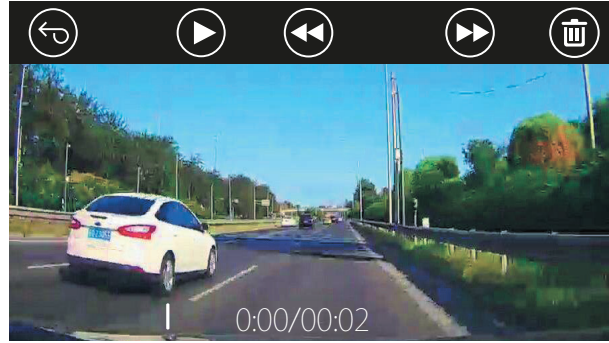
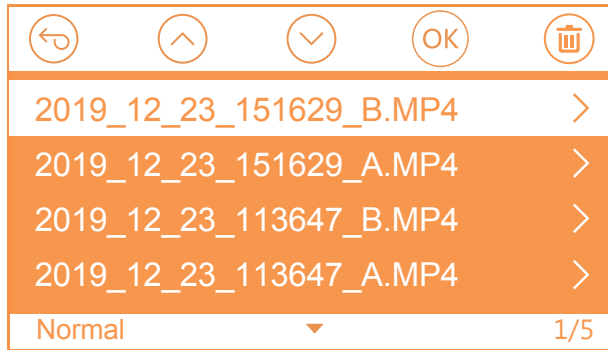

View on a computer

1. Connect the camera to your computer using the supplied Type-C USB cable.
2. “USB Connecting” and “Power on” will be displayed on the camera screen, please navigate to “USB Connecting” and press **OK** button to transfer data.
3. Depending on your computer OS, the device will appear either as a removable drive or a removable volume.

View on a TV

The camera has a Micro HDMI port for connecting an external display such as a monitor or TV. Please note that the product doesn't come supplied a Micro HDMI to HDMI cable.

1. Use a USB charger to charge the camera.
2. Insert the Micro HDMI connector into the camera's HDMI port.
3. Insert the HDMI connector end into your TV or monitor's HDMI port.
4. Adjust your display settings to detect the HDMI input source.
5. Once connected to your TV, the camera's screen will turn black and be output to your TV screen.

NOTE:

1. To use the HDMI Output Mode, the camera requires a constant power connection via USB.
2. When connected to an external display, the camera's video recording function is disabled.

4.14 Delete Videos on the Dash Cam

Delete Normal Files

Go to Normal file, choose a video on the dash cam, press the (⏻) button, then press the (OK) button to select "Delete" section, press (OK) button to select Delete.

Delete Event Files

Go to Event file, choose a video on the dash cam, press the (⏻) button, then press the (OK) button to select "Delete" section, press (OK) button to select Delete.

4.15 Auto LCD Off

This feature avoids any chance of the screen being a distraction in the vehicle, especially at night when the illumination from the LED screen can be a nuisance or even a hazard to the driver. If you set the Auto LCD Off to 3 minutes, the camera's LCD will light off after 3 minutes but recording will continue with blue light blinks on the Indicator light. You can press any button to light on the screen.



Please go to System Setup to adjust this time to 30 sec, 1Min, 3Min, or OFF to disable it so the LCD can always stay on.

4.16 Upgrading the Firmware

The system will automatically update if the microSD card contains the firmware upgrade file. The camera will restart once the upgrade has been completed.

Always stay up-to-date

The latest firmware version is always available at the official VANTRUE website (www.vantrue.net). We strongly recommend registering your product (www.vantrue.net/register) to receive a notification email when a new firmware update is available.

4.17 Working Temperature

The camera is designed to operate in temperatures from 14-158° F (-10° C to 70° C) , temperatures outside this range risk degrading the camera's performance work and causing damage.

To avoid damage

- In hot weather, do not expose the camera directly to the sun when the car is parked.
- In extreme winter conditions, i.e. -4 (-20) or lower, detach the camera from the windshield when not in use, and store in the glove box.

5. Specifications

The specifications of this product may change without prior notice due to product improvements.

Model	N4
Image sensor	Front: SONY STARVIS 5M CMOS Sensor Cabin: SONY STARVIS 2M CMOS Sensor Rear: SONY STARVIS 2M CMOS Sensor
Channels	3 Channel
LCD	2.45" IPS LCD, 480x272
Lens	Front: F1.4, 155 degree wide angle lens Cabin: F2.0, 165 degree wide angle lens External Camera: F1.8, 160 degree wide angle lens
Languages	English/Japanese/Spanish/French/Italian /简体中文(Simplified Chinese)/ Deutsch /Russian
Video resolution	Front+Cabin+Rear Mode: 1440P+1080P+1080P 30FPS; 1080P+1080P+1080P 30FPS; 1080P+1080P+720P 30FPS; 720P+720P+720P 30FPS Front+Cabin Mode: 1440P+1080P 30FPS; 1080P+1080P 30FPS; 1080P+720P 30FPS; 720P+1080P 30FPS; 720P+720P 30FPS Front+Rear Mode: 1440P+1080P 30FPS; 1080P+1080P 30FPS; 1080P+720P 30FPS; 720P+1080P 30FPS; 720P+720P 30FPS Front mode: 2592x1520P 30FPS; 2560x1440P 30FPS; 1920x1080P 30FPS; 1280x720P 30FPS

Video File Format	MP4
Audio	Built-in microphone and speaker
External memory	Micro SD card (U3 or higher, up to 256GB)
Shutter Type	Electronic
USB Port	Type-C
Battery type	super-capacitor
Working voltage	5V 1.5A
Working current	800mA(Typical value) / DC 5V
Working Temperature	14-158° F (-10° C to 70° C)
Storage Temperature	-4 to 176° F (-20° C to 80° C)
Compatible OS	Windows XP/Vista/7/8/10 &Mac OS

6. Warranty & Support

Warranty

The VANTRUE® OnDash N4 Dash Cam comes with a full 12 months warranty.

If you register your product on our official site (www.vantrue.net/register), you can extend the warranty to 18 months.

Support

If you have any questions regarding your product, please do not hesitate to contact us via Amazon or drop us an email at support@vantrue.net. Queries are typically answered within 12-24 hours.

Your opinion matters

VANTRUE® is firmly committed to always improving our products, services, and user experience. If you have any thoughts on how we can do even better, we welcome your constructive feedback and suggestions. Connect with us today at support@vantrue.net.

THANK YOU for choosing VANTRUE®